

Lowell Joint School District
11019 Valley Home Avenue, Whittier, CA 90603

MINUTES REGULAR MEETING OF THE BOARD OF TRUSTEES

August 8, 2022

Call to Order	President Salinas called the meeting to order at 6:30 p.m. at Lowell Joint School District, 11019 Valley Home Avenue, Whittier, CA 90603.
Topics Not on the Agenda	None.
Closed Session	President Salinas declared the meeting recessed to closed session at 6:31 p.m.
Call to Order	President Salinas reconvened the meeting to order at 7:33 p.m.
	The flag salute was led by Karen Shaw, Board of Trustees Vice President.
Trustees Present:	Melissa A. Salinas, Karen L. Shaw, Anastasia M. Shackelford, Anthony A. Zegarra
Trustees Absent:	None
Staff Present:	Jim Coombs, Superintendent of Schools, Sheri McDonald, Assistant Superintendent of Educational Services, and David Bennett, Assistant Superintendent of Facilities and Operations
Staff Absent:	Andrea Reynolds, Assistant Superintendent of Administrative Services
Reporting out Action (if any) Taken in Closed Session	None.
Introductions and Welcome of Guests	President Salinas welcomed the guests in attendance, staff members present, Allison Fonti, LJEA president, Leslie Mangold, LJEA lead negotiator and CSEA President, Darleene Pullen.
Acknowledgement of Correspondence	None.
Approval of Agenda	It was moved, seconded, and carried by unanimous vote, (4 – 0) to approve the amended August 8, 2022, Board agenda.
Approval of Minutes	It was moved, seconded, and carried by unanimous vote, (4-0) to approve the minutes from the June 27, 2022, Regular Board Meeting.
Timely Information from Board and Superintendent – Board President	None.

Topics Not on the Agenda	None.
2022/23 Budget Update	<p>Education Code Section 42147(h) states: “Not later than 45 days after the Governor signs the annual Budget Act, the school district shall make available for public review any revisions in revenues and expenditures that it has made to its budget to reflect the funding made available by that Budget Act.” While this language does not specifically require that districts revise their budgets at this time, it does require making the revisions public if the district decides to make revisions based on the Enacted State Budget.</p> <p>The Governor signed the 2022-23 State Budget into law on June 27, 2022, beginning the 45-day period, which ends on August 11, 2022. The Board adopted the district budget on June 27, 2022. Due to significant differences between the State Enacted Budget and the proposed budget in the May Revision, which was used to present the 2022/23 Adopted Budget, updates to the Board of Trustees and the public of the significant changes are advisable. Many of these numbers are estimates at this time, and the district’s First Interim budget presented on December 12, 2022, will reflect the most current figures available.</p>
Approval of Professional Services Agreement for Utility Locating and Mapping Services with C Below Subsurface Imaging at Rancho Starbuck Intermediate School	<p>It was moved, seconded, and carried by unanimous vote, (4-0) to approve the ratification of the Professional Services Agreement with C Below for surveying and mapping at Rancho Starbuck Intermediate School, effective August 9, 2022 through August 8, 2023, not to exceed \$18,915, to be paid by (21.0-00000-0-00000-85000-62000-0011000), and that the Superintendent or designee be authorized to execute the necessary documents.</p>
Ratification of Additional Professional Services Agreement with A-Tech Consulting for Hazardous Materials Monitoring, at Meadow Green Elementary School	<p>It was moved, seconded, and carried by unanimous vote, (4-0) to approve the ratification of the additional Professional Services Agreement with A-Tech Consulting for Hazardous Materials Monitoring at Meadow Green Elementary School, effective August 9, 2022 through August 8, 2023, not to exceed \$4,475.00, to be paid from (21.0-00000-0-00000-85000-6282-0040000) Measure LL (21.0 Bond Fund), and that the Superintendent or designee be authorized to execute the necessary documents.</p>
Approval of Prime Contract Change Order #002, to Increase the Guaranteed Maximum Price with Erickson Hall Construction Company, Inc. to Replace the Main Switch Board at the Meadow Green Elementary School Project	<p>Ms. Shaw asked if this was part of the LL Funding. Mr. Bennett said yes. Mrs. Shackelford asked if it has in the future the capability of being solar. Mr. Bennet said yes.</p> <p>It was moved, seconded, and carried by unanimous vote, (4-0) to approve the Prime Contract Change Order #002 to increase the Guaranteed Maximum Price with Erickson Hall Construction Company, Inc. for the replacement of the main switch board at the Meadow Green Elementary School Project, effective August 9, 2022 through August 8, 2023, not to exceed \$71,686, to be paid by (21.0-00000-0-00000-85000-6210-008000) Measure LL (21.0 Bond Fund), and that the Superintendent or designee be authorized to execute the necessary documents.</p>

Approval of Change Order for Additional Professional Services Agreement with RMA Group for Monitoring, Testing, and Inspecting at Jordan Elementary School

It was moved, seconded, and carried by unanimous vote, (4-0) to approve the ratification of an additional Professional Services Agreement with RMA Group for Monitoring, Testing, and Inspecting at Jordan Elementary School, effective May 3, 2022 through May 1, 2023, not to exceed \$10,452, to be paid by (21.0-00000-0-00000-85000-6282-0040000) Measure LL (21.0 Bond Fund), and that the Superintendent or designee be authorized to execute the necessary documents

Award District-Wide Solid/Organic Waste and Recycling Services to WARE Disposal, Inc. (RFP# 202122-03)

It was moved, seconded, and carried by unanimous vote, (4-0) to award district-wide solid/organic waste and recycling services to WARE Disposal, Inc., (RFP# 202122-03), and that the Superintendent or designee be authorized to execute the necessary documents.

Consent Calendar

It was moved, seconded, and carried by a unanimous vote, (4 – 0), to approve/ratify the following items, under a consent procedure.

Approval of Ratified Consultant Agreement with Debra Lees to provide support for the Lowell Sustainable Science Literacy Garden at the Maybrook Campus during 2022-2023 School Year

Approved the ratified consultant agreement with Mrs. Debra Lees to provide support for the Lowell Joint Sustainable Science Literacy Garden at the Maybrook Campus for the 2022/2023 school year, at the not to exceed amount of \$15,120.00, to be paid from the Title IV Student Support and Academic Enrichment funds, and that the Superintendent or designee be authorized to execute the agreement.

Approval of Memorandum of Understanding With Walnut Valley Consortium Induction Program, Effective July 1, 2022 through June 30, 2023

Approved the ratified Memorandum of Understanding with Walnut Valley Consortium Induction Program, Effective July 1, 2022 through June 30, 2023, at a cost of \$3000 per qualified teacher to the district, to be paid from the General Fund/Educator Effectiveness Grant, and that the Superintendent or designee be authorized to execute the necessary documents.

Approval of Memorandum of Understanding Educational Fieldwork Agreement with University of Redlands, Effective July 1, 2022 through June 30, 2024

Approved the Memorandum of Understanding Educational Fieldwork Agreement with University of Redlands, effective July 1, 2022 through June 30, 2024, at no cost to the district, and that the Superintendent or designee be authorized to execute the necessary documents.

Approval of Consultant Agreement with Mrs. Linda Takacs to Serve as the Director, Lowell Joint Induction Program for the 2022-2023 School Year

Approved the consultant agreement with Mrs. Takacs to serve as the director of the Lowell Joint induction program for the 2022-2023 school year, not to exceed \$35,000.00, to be paid from the general fund / educator effectiveness grant, and that the Superintendent or designee be authorized to execute the necessary documents.

Purchase Order Listing Report/Check Register 2022/2023 #1

Approved the Purchase Order Listing Report/Check Register 2022/2023 #1, issued June 01, 2022, through June 30, 2022, as attached, and that the Superintendent or designee be authorized to execute the necessary documents.

Consolidated Check Register Listing Report 2022/2023 #1

Approved the Consolidated Check Register Listing Report 2022/2023 #1, issued June 01, 2022, through June 30, 2022, as attached, and that the Superintendent or designee be authorized to execute the necessary documents.

Approval of Contract with Whittier Christian High School, for Student transportation to and from the Meadow Green and Maybrook Campuses during Meadow Green Modernization (Bond Fund

Approved the Contracted Services Agreement with Whittier Christian High School, for student transportation to and from the Meadow Green and Maybrook Campuses, effective August 9, 2022 through August 15, 2023, not to exceed \$68,250, to be paid from Measure LL General Obligation Fund (21.0), and that the Superintendent or designee be authorized to execute the necessary documents.

Approval of Agreement with Administrative Services Cooperative, Inc. for Student Transportation Services for the 2022/2023 School Year Not to Exceed \$150,000

Approved the agreement with Administrative Services Cooperative, Inc. for Student Transportation Services for the 2022/2023 School Year Not to Exceed \$150,000, and that the Superintendent or designee be authorized to execute the necessary documents.

Approval of Agreement with Geraldine Chinarian, for Specialized Consulting Services

Approved the Agreement the agreement with Geraldine Chinarian, at an hourly rate of \$100 an hour, from August 9, 2022 through June 30, 2023, not to exceed four hundred (400) hours, and that the Superintendent or designee be authorized to execute the necessary documents.

Approval of Agreement with Ho Chong (Christina) Choi, for Specialized Consulting Services

Approved the agreement with Ho Chong (Christina) Choi, at an hourly rate of \$85 an hour, from July 1, 2022 through June 30, 2023, not to exceed four hundred (400) hours, and that the Superintendent or designee be authorized to execute the necessary documents.

Budget Adjustments 2021/22 – Estimated Actuals

Approved the Budget Adjustments for 2021/22 Estimated Actuals, and that the Superintendent or designee be authorized to execute and file the necessary documents.

Employer-Employee Relations/Personnel Report 2022/2023 #1 Which Includes Hiring, Resignations, Contract Adjustments, and

Ratified Employer-Employee Relations/Personnel Report 2022/23 #1, as attached, which includes hiring, resignations, contract adjustments, and retirements for certificated, classified, and confidential employees.

Retirements for Certificated,
Classified, and Confidential
Employees

Approval of Memorandum
of Understanding By and
Between the Orange County
Department of Education
and Lowell Joint School
District for MHSSA
Partnership during the 2021
- 2024 School Years

Approved the Memorandum of Understanding by and between the Orange County Department of Education and Lowell Joint School District for MHSSA Partnership during the 2021 - 2024 school years, and that the Superintendent or designee be authorized to execute the necessary documents.

Approval of Agreement
#10001508 with the Orange
County Department of
Education to provide NGSS
Professional Learning
during the 2022/23 School
Year

Approved the Agreement with Orange County Department of Education for NGSS Professional Learning during the 2022-23 school year for a total not to exceed \$2,700.00, to be paid by educator effectiveness funds, that the Superintendent or designee be authorized to execute the necessary documents.

Approval of Memorandum
of Understanding Between
Boys & Girls Club of La
Habra and Lowell Joint
School District

Approved the MOU with Boys & Girls Club La Habra and Lowell Joint School District, for the 2022-2023 school year, family to pay fees directly to the boys and girls club of La Habra, and that the Superintendent or designee be authorized to execute the necessary documents.

Approval of Agreement
#13249 with Thinking
Maps Inc. to Provide
Professional Development
During the 2022-23 School
Year

Approved the agreement with Thinking Maps Inc. to provide on-site Professional Development during the 2022-23 school year at a cost of \$8,800 for Agreement #13249, to be paid by Title II funds, and that the Superintendent or designee be authorized to execute the necessary documents.

Approval of Agreement
#13256 with Thinking
Maps Inc. to Provide
Professional Development
During the 2022-23 School
Year

Approved the agreement with Thinking Maps Inc. to provide on-site Professional Development during the 2022-23 school year at a cost of \$10,000 for Agreement #132564271, to be paid by Title II funds, and that the Superintendent or designee be authorized to execute the necessary documents.

Board
Member/Superintendent
Comments

Mrs. Shackelford said she would not be able to attend the staff welcome back on Monday since she was starting school in her district on Monday. She wanted to wish the staff a wonderful start to the year and to convey those wishes to everybody. Mr. Coombs said that the coming Friday was the new certificated staff orientation. Mrs. Shackelford said that her youngest is now in seventh grade at Rancho as he expressed how he would get to school by riding his bike. Ms. Shaw and Mr. Zegarra both have seventh graders going into Rancho as well. Mr. Zegarra also wished the

parents a wonderful year as well.

Adjournment

President Salinas adjourned the meeting at 7:52 p.m. in accordance with Government Code Section 54956.9 (a, b, c) and indicated no further public action would be taken

Date Approved:

9/12/22



Clerk/President/Secretary to the Board of Trustees

GPR
Mapping
Potholing
Utility Locating
CCTV Pipe Inspection

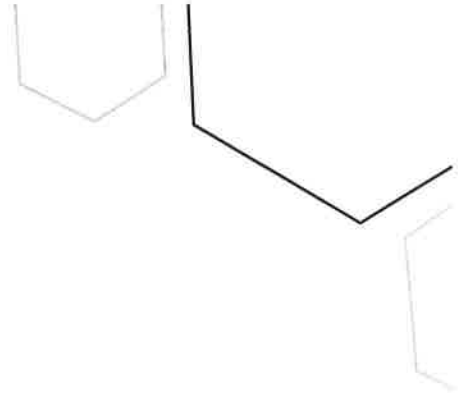

BELOW
SUBSURFACE IMAGING

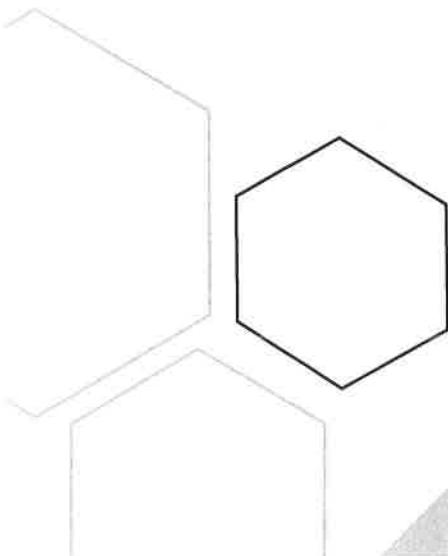

www.cbelow.com
1-888-90-BELOW
14280 Euclid Ave.
Chino, CA 91710
CL# 959964



Estimate
Job 22-5479
Quote No. Q-14143
Date: 06-16-2022
Expires on: 07-16-2022
Payment Prevailing Wage | Net 30

C Below | Subsurface Imaging

Call Before you cut, core, drill or dig.

14280 Euclid Ave Chino, CA 91710
Phone: **(888) 902-3569** Fax: (909)606-6555
www.cbelow.com

Bill To

Ghataode Bannon Architects, LLP
760 W. 16th Street, Unit B
Costa Mesa
CA
92627

Opportunity Name

**Rancho Starbuck Utility Locating, Mapping and
CCTV**
Primary

Primary Contact

J. Ben Regalado
714-665-8030
bregalado@gbarchitects.net

Jobsite Address

Sales Rep	Ext.	Email	Cell
Victoria Franco	210	victoriaf@cbelow.com	

C Below, Inc. submits this proposal for the Rancho Starbuck Utility Locating, Mapping and CCTV project. Our proposal is based on the enclosed estimated hourly breakdown and the C Below Schedule of Fees. In order to successfully complete the outlined scope of services in this proposal our field technicians will need uninterrupted clear access to the work area and the appropriate project documentation. We appreciate the opportunity to provide you with our services and look forward to helping assure a safe and successful project.



14280 Euclid Avenue
Chino, CA 91710

Utility Locating Scope of Work

C Below will provide a comprehensive Utility Investigation of the outlined area shown on Exhibit A (last page of proposal).

The purpose of this investigation is to find all utilities outlined below to quality level (QL) B per ASCE 38-02. (see attached documentation on available quality levels).

C Below will exhaust any and all utility locating methods, plus "tribal knowledge", to positively identify the horizontal and vertical locations of the utility lines.

This includes utilizing the equipment listed below:

- *Electromagnetic Locator (Locator)*
- *Locatable CCTV Push Camera. No video will be provided unless specifically included in your quote. (Push Cam)*
- *Ground Penetrating Radar (GPR).*
- *Locatable Duct Rodder (Ram Rod).*
- *Crawler Camera and lateral Launch Equipment if specifically included in your quote. (Crawler)*

Deliverables- Utility locations along with depth estimates will be marked directly on the surface (Please reference your Markings Card for explanations of these).



14280 Euclid Avenue
Chino, CA 91710

Mapping Scope of Work

At the completion of this project the client will be provided a comprehensive 2D utility map in CAD and PDF. Client shall provide CAD background for utilities to be added to. While our maps do include utility depth estimates from the surface, survey elevations are not included unless specifically requested at the time of this estimate.

PHASE 1 | Utility Mark Out w/ Waterbased Paint. Utility marks will remain on the site unless the client has hired C Below to remove the markings.

PHASE 2 | C Below's Mapping Team will pick up the markings with the depth estimates from PHASE 1. Mapping shall be completed within a reasonable time frame to assure integrity of marks.

PHASE 3 | Quality review with the Lead Technicians and the Mapping Team to ensure the quality of the deliverable and applicable notes.



14280 Euclid Avenue
Chino, CA 91710

CCTV Scope of Work

C Below will perform CCTV pipe inspection on Sewer and/or Storm Drain lines within the marked area of investigation on the attached exhibit.

CCTV cannot be performed on blocked lines, laterals that are inaccessible, or lines that are full. It is recommended that Jetting be performed on lines that are blocked only to assist with our CCTV inspection.

CCTV Inspection does not include removal of toilets for access or mapping of line locations.

Client will be provided with a digital file and report of the inspection. Line sizes in these reports are estimates of the interior and may vary.



Estimate
Job 22-5479
Quote No. Q-14143
Date: 06-16-2022
Expires on: 07-16-2022
Payment Prevailing Wage | Net 30

Product Line Items

Product	Quantity	Sales Price	Total Price
Admin	2	\$95.00	\$190.00
CCTV Report	1	\$250.00	\$250.00
CCTV Robotic Camera Pipe Inspection	8	\$385.00	\$3,080.00
Drafting	4	\$125.00	\$500.00
Locating Locating Technician	28	\$175.00	\$4,900.00
Locating Supervising Technician	28	\$195.00	\$5,460.00
Mapping	12	\$230.00	\$2,760.00
Mobilization Crew	5	\$225.00	\$1,125.00
Mobilization Single Tech	2	\$135.00	\$270.00
Project Coordinator	4	\$95.00	\$380.00
Total USD			\$18,915.00

Product Descriptions

Product Item	Description
Admin	Project Administration.
CCTV Report	CCTV Report including observations and photos.
CCTV Robotic Camera Pipe Inspection	Robotic Pipe Inspection. Includes locating and video.
Drafting	Drafting for utility findings.
Locating Locating Technician	Locating Locating Technician
Locating Supervising Technician	Locating Supervising Technician
Mapping	Mapping of utility findings.
Mobilization Crew	Mobilization Crew
Mobilization Single Tech	Mobilization Single Tech



Estimate
Job 22-5479
Quote No. Q-14143
Date: 06-16-2022
Expires on: 07-16-2022
Payment Prevailing Wage | Net 30

Project Coordinator	Project Coordinator
---------------------	---------------------

Quality Level Definitions

Quality Level D is the most basic level of information for utility locations. It comes solely from existing utility records or verbal recollections, both typically unreliable sources. It may provide an overall "feel" for the congestion of utilities, but is often highly limited in terms of comprehensiveness and accuracy. QL-D is useful primarily for project planning and route selection activities.

Quality Level C involves surveying visible utility facilities (e.g., manholes, valve boxes, etc.) and correlating this information with existing utility records (QL-D information). When using this information, it is not unusual to find that many underground utilities have been either omitted or erroneously plotted. Its usefulness, therefore, is primarily on rural projects where utilities are not prevalent, or are not too expensive to repair or relocate.

Quality Level B involves the application of appropriate surface geophysical methods to determine the existence and horizontal position of virtually all utilities within the project limits. It addresses problems caused by inaccurate utility records, abandoned or unrecorded facilities, and lost references. Decisions regarding location of storm drainage systems, footers, foundations and other design features can be made to successfully avoid conflicts with existing utilities. Slight adjustments in design can produce substantial cost savings by eliminating utility relocations.

Quality Level A is the highest level of accuracy and involves the full use of the subsurface utility investigation method. It provides information for the precise plan and profile mapping of underground utilities through the nondestructive exposure of underground utilities, and also provides the type, size, condition, material and other characteristics of underground features.

Service Exceptions and Limitation

Locating Exceptions

Our services do not include the location of irrigation lines and associated control valves. We are able to locate sewer and storm drain lines if access is made available. We do not locate abandoned/extra conduits containing no interior cable and we do not locate fiber optic lines or lines without a metallic shield or lacking a tracer wire. C Below has the ability to locate nonmetallic lines but it is outside our normal scope of services. Should the need arise to locate these types of lines, please contact us for an additional quote.

GPR Exceptions

There needs to be at least 8 inches clearance around the perimeter of the scanning area to accommodate the GPR antenna; especially at structure intersections. Scanning surfaces need to be relatively flat with no water present. GPR can penetrate 12 inches of concrete or masonry, but accuracy decreases with increased steel congestion. Indications show up on the radar screen as hyperbolas. The center of the hyperbola is the center of the indication. GPR data, under most circumstances, does not allow for the interpretation of an indications size, only the center location of the indication and embedment depth. Indications such as reinforcing steel or conduit spaced closer than 2 inches on center may show up as one indication.

Mapping Exceptions

Please be sure to provide any project documents prior to dispatch. A workable CAD file is required if mapping is to be performed. JPG, TIFF, PDF files are not preferred and may affect the quality of the final product. If no CAD file can be provided, additional costs may apply. A complete and editable background must be provided by the client to ensure the quality of the final product.

Potholing Exceptions

For billing purposes, C Below defines a standard pothole with the dimensions of 1' X 1' X 5' deep. Deviations from this standard definition require rate increases for additional time and materials to facilitate the client requests. Because potholing rates and other associated costs are based on the assumption of 8 hour work days, additional fees may apply if work is limited to less than 8 hours per day. These fees may include, but are not limited to: additional traffic control, travel time, and disposal fees. Standard pothole pricing includes holes at locations with a soil surface or an asphalt surface up to 6-inches thick. Additional fees will apply if the asphalt surface is over 6" thick or the proposed hole location has a concrete surface. If during the potholing operation the soil is found to have large aggregate or other debris over 3-inches in diameter, ground water, roots or hazardous materials, additional fees will apply. For further clarification please speak to your C Below representative. Optional Services include: hot patching per City requirements, slurry backfill, standard or engineered traffic control plans, trenching or excavation beyond standard pothole dimensions.

CCTV Exceptions

All lines designated by the client for need of inspection must have clear unobstructed access points. Information gathered during the inspection must be agreed upon prior to dispatch. For added scope of water jetting additional fees apply.

Traffic Control

Standard Traffic Control includes one lane closure with minimal signage not spanning an intersection. Extensive Traffic Control includes multiple lane closures, arrow boards, multiple signage requirements, spanning of intersections, flaggers, and other non-standard setups.

General Terms and Conditions for Services

Provided by C Below, Inc.

For the remainder of this document, C Below, Inc. will be referred to as CBI and the Owner or Owner's representative will be referred to as the CLIENT.

ANTICIPATED COSTS

CBI's estimated budget is based upon information provided by the Client. Our ability to perform within the estimated budget depends heavily on the accuracy of the information provided, as well as the cooperation and attentiveness of the Client's management staff. Our accounting department will provide the Client with a percentage of the estimated budget used on each invoice. The Client's management staff shall monitor the percentage of work remaining to assure CBI's services are not greater than the estimated budget. If CBI performs less work than the estimated budget, the Client's costs will be less. Likewise, if the duration of our services exceeds our estimated budget, the Client will incur more cost. Verbal requests made by project representatives to perform services beyond our estimated budget are considered authorization to perform billable work. Project actual budget totals may vary. Estimated budget hours are based on a 40-hour/Monday - Friday workweek, 8-hours per day, excluding weekends, holidays and overtime. The Client agrees that any "budget estimates", "anticipated costs" or other like documentation prepared by CBI is NOT a "not to exceed budget", "guaranteed maximum" or "lump sum". The Client will be invoiced for all work performed based on CBI's Schedule of Fees and these Terms & Conditions.

MINIMUM CHARGES

All locating services are based on a minimum of four hours. Over four hours shall be a minimum of eight hours. If a technician is scheduled to perform a service and no work is performed, a two hour minimum charge shall apply (show-up charge).

WORKING HOURS

CBI's regular workweek is Monday - Friday. Normal work hours are 7:00 am - 5:00 pm. For work performed Monday - Friday, overtime hours (1.5 times the contracted hourly rate) apply after eight hours worked per day. Premium time hours (2 times the contracted hourly rate) apply after twelve hours worked per day. Work performed on Saturday shall be billed at 1.5 times the contracted hourly rate. Work performed on Sundays and Holidays shall be billed at 2.0 times the contracted hourly rate. Holidays observed by CBI are New Year's Day, Memorial Day, Independence Day, Labor Day, Veterans Day, Thanksgiving, the day after Thanksgiving and Christmas. Overtime hour charges shall be in one-hour increments.

SCHEDULING & CANCELLATION

A minimum of 24-hours notice is required when scheduling CBI's services. If services are requested the same day or after 2:00 pm the preceding day, a premium expedite fee of \$75 per technician will apply. If services are canceled less than 24-hours before the scheduled start time, a fee of \$75 per technician will apply.

PREVAILING WAGE

The prices quoted within are NOT Prevailing Wage or Union unless specifically stated on the first page of this document. If this project requires Prevailing Wage, our hourly rates will increase the proportional percentage increase every July 1 in accordance with the wage listed by the Director of Industrial Relations which is tied to any applicable union or collective bargaining agreement documented annual increases plus corresponding changes in our general administration and overhead expenses. These adjustments shall become the agreed upon basis for charges by CBI to the Client.

CERTIFIED PAYROLL

Certified payroll requests will have a processing fee applied for each project, billed on every invoice in the amount of \$75.00.

C.O.D.

Projects totaling less than \$5,000.00 in services for Clients that have not submitted credit approval through the CBI accounting department shall be performed on Cash on Delivery (C.O.D.) basis. Prior to the start of our services the CBI technician will collect a check from the Client. For all other projects, please see the TERMS OF PAYMENT section of this document.

TERMS OF PAYMENT

The Client agrees invoices rendered for professional or technical services will be prepared bi-monthly and are due upon presentation. Invoices will be deemed past due if unpaid within thirty (30) days from date of invoice, and will be subject to a monthly finance charge of 1.5% of invoice total for each month unpaid. All invoice errors or necessary corrections shall be submitted to CBI within fifteen (15) days of receipt of the invoice; thereafter the Client acknowledges the invoice is correct and valid for payment due to CBI. CBI reserves the right to terminate services to the Client without notice if the Client's account is not paid currently. Upon such termination of services, the entire amount accrued for all services performed shall immediately become due and payable to CBI. The Client waives any and all claims against CBI, its subsidiaries, affiliates, servants and agents in connection with termination of work/services pursuant to this agreement. In the event CBI deems it necessary to refer a past due account to an attorney or to file suit for collections, the Client agrees to pay all actual expenses and costs incurred there by, including CBI staff costs, actual attorney fees & costs, and all related costs in such litigation. Jurisdiction and venue of all such actions and any other actions arising from this agreement or the provision of services by CBI shall be in San Bernardino County, State of California.

INSURANCE

CBI carries all insurance required by law. Additional insurance coverage can be obtained at an additional cost to the Client. These costs can be obtained by quotation from CBI. CBI will process Waiver of Subrogation, Additional Insured's, and Additional insurance certificates upon request from the Client. An additional charge of \$150 will apply for each document required and will be invoiced to the Client.

REIMBURSABLE EXPENSES

Outside services performed by others and direct costs expended on the Client's behalf, are charged at cost plus 15%. Equipment and materials purchased/rented by CBI exclusively for the project will be invoiced at cost plus 15%. Business license fees for project specific requirements will be invoiced at cost plus 15%.

SERVICE AUTHORIZATION

Verbal request will be considered authorization to perform billable work. The Client shall designate member(s) of their staff who have authority to request our services and notify CBI in writing as to their authorized representative. Otherwise all service requests are billable.

PROPOSAL VALID DURATION

Proposed Master Fee Schedule of Rates, Term & Conditions and General Conditions stated within are valid for 30 days from proposal date.

CONTRACTUAL ADDITIONS

C Below will undertake professional responsibility for only the services provided pursuant to this Agreement, and only pursuant to the terms and conditions of this Agreement. In particular, and without limitation, C Below will not be responsible for delays or other matters beyond its reasonable control; for inaccurate or incomplete information provided to it by Client, co-consultants or other reasonably reliable sources; for site conditions of which it was not actually informed; for unauthorized modifications to or deviations from C Below's instruments of service or the use of unfinalized instruments of service for any purposes including bidding or cost estimating; for hazardous materials or toxic substances at the Project site; for the specification of products or equipment for purposes consistent with the manufacturer's published literature; for materials and equipment decisions made by others; for the services and instruments of service provided by others even if incorporated into C Below's instruments of service for ease of reference or otherwise; for the performance of the Project's contractors and materials suppliers; for construction means, methods, techniques, sequences or procedures, including without limitation investigation or demolition procedures and safety precautions and programs; and for the actions or inactions of others including utility companies, other consultants and governmental or quasigovernmental agencies.

The services being provided for by C Below do not relieve the Client of the responsibility of having to comply with California Government Code §§4216 - 4216.9. It is expressly understood by the Client that C Below's services are not a substitute for compliance with California government Code §§4216 - 4216.9.

In recognition of the relative risks, rewards and benefits of the project to both the Client and C Below, the risks have been allocated such that the Client agrees that, to the fullest extent permitted by law, C Below's total liability to the Client and to any other third party for any and all injuries, claims, losses, expenses, damages or claims expenses arising out of this agreement from any cause or causes, shall not exceed C Below's fee or \$5,000.00, whichever is less. Such causes include, but are not limited to, C Below's negligence, strict liability, breach of contract or breach of warranty.

The Client waives all rights against C Below for damages caused by fire, water, wind or any other perils to the extent covered by any type of property insurance applicable to the claimed damage or loss. This waiver of subrogation shall be effective even though that person or entity would otherwise have a duty of indemnification.

The Client shall ensure that all of its contractors and subcontractors maintain General Liability Insurance (minimum of \$1,000,000 per occurrence limits of coverage). Modified occurrence policies are not acceptable; any coverage exclusion in addition to standard ISO coverage forms must be noted and approved by C Below. The Client will require and make certain that its contractors and subcontractors list C Below as an additional insured using ISCO CG2010 1985 Form B or equivalent with no limitation to "ongoing operations" for each project C Below performs services for the Client. The additional insured endorsement or certificate must also contain a statement that "the protection afforded the additional insured hereunder shall be primary and any other coverage available to the additional insured shall be excess and non-contributing."



14280 Euclid Ave
Chino, CA 91710
1-888-90-BELOW
Fax: (909) 606-6555

UTILITY LOCATING

Utility locating is an imperative first step prior to geotechnical excavation during pre-construction. Damaged lines are not only expensive to repair but can be extremely dangerous. Starting your project with the knowledge of the types and locations of underground utilities on the job site is an important and cost-effective way to ensure a safe and successful project.

C Below has the ability to locate horizontal and vertical locations for all underground utilities including: water, gas, power, waste, communications and cable/TV.

Our technicians will mark all indications directly on the surface of all surveyed areas using the American Public Works Association (APWA) Uniform Color Code. All utility locating marks are made in accordance with the Common Ground Alliance (CGA) Best Practices.

Once lines have been found, there are several options a technician can use for marking the utility locations. Spray paint is the most common but flags or whiskers are also utilized in areas that have heavy traffic, or where sprinklers may cause the paint to become unreadable prior to excavation. Computer-aided design or CAD drawings of our findings can also be provided upon request.

Our utility locating services shall include only those materials commonly used for locating and marking indications. Clear access to scanning areas need to be provided by the client. Should the area to be scanned not be accessible from the ground, the client will provide the means (man lift, scaffold, etc.) for our technician to properly perform their work.

For utility locating we locate all underground utilities using a standard electromagnetic utility locator. With this method, we are able to find: main water supply lines and associated branch lines made of metal (conductive) or water lines installed with a "tracer wire", all sewer and waste lines by electromagnetic location, power lines, telecommunication lines, gas lines with tracer wires.

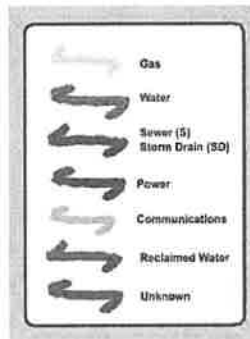

EXCEPTIONS

Our services do not include the location of irrigation lines and associated control valves. We are able to locate sewer lines if access is made available. We do not locate abandoned/extra conduits containing no interior cable and we do not locate fiber optic lines or lines without a metallic shield or lacking a tracer wire. C Below has the ability to locate nonmetallic lines but it is outside our normal scope of services. Should the need arise to find these types of lines, please contact us for an additional quote.





14280 Euclid Ave
Chino, CA 91710
1-888-90-BELOW
Fax: (909) 606-6555

GROUND PENETRATING RADAR (GPR)

C Below uses GPR for locating reinforcing steel, prestressing strand, conduit and other indications in concrete and masonry structures. We use this method because it is one of the safest, fastest and most accurate methods currently available. With the ability to penetrate up to 18 inches of concrete, our technicians can map all indications directly on the scanning surface prior to coring, cutting or drilling. The survey results can also be saved and printed in 3-Dimensional detail providing a subsurface map for our client.

With such a large penetration range, GPR can be used with access to only one side of the scanning area with no need to place film on the opposite surface (as is needed with other methods). Our technicians determine the thickness of concrete and masonry structures to determine the spacing and depth of indications. In certain cases, the size of the indication can be estimated.

As these indications are found, they are displayed to the technician in real-time. They are displayed on the GPR monitor when changes in the conductivity of the scanned area represent locations of rebar, conduit, pipe, voids, and other objects located beneath the surface. Once located, the indication is marked in accordance with the APWA Uniform Color Code.

GPR is incredibly versatile and offers ease of use on job sites. It emits about 1% the power of a cell phone signal to perform its functions. Other methods require a safety perimeter around work areas. We prefer to use GPR because we are able to work in occupied sites and buildings where temporary evacuation is not an option. The equipment is very portable and can be moved to location quickly, making scanning of multiple areas a fast, efficient and manageable process. The practicality of this service supersedes traditional methods of utility locating, but it can also be used in conjunction with them.

With the ability to locate nonmetallic utilities up to 12 feet deep, you can be sure most lines will be identified.

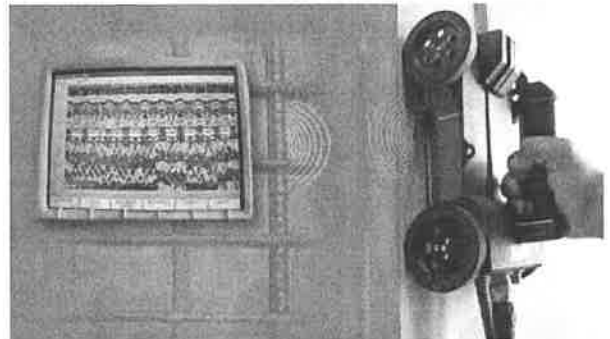

EXCEPTIONS

There needs to be at least 8 inches clearance around the perimeter of the scanning area to accommodate the GPR antenna; especially at structure intersections. Scanning surfaces need to be relatively flat with no water present. GPR can penetrate 16 inches of concrete or masonry, but accuracy decreases with increased steel congestion. Size of indications are hard to determine as GPR readings are presented in a fashion that communicates location rather than the indication's expanse.





14280 Euclid Ave
Chino, CA 91710
1-888-90-BELOW
Fax: (909) 606-6555

UNDERGROUND MAPPING

C Below will provide our client with electronic and/or printed documentation of our utility investigation when mapping is added to our locating scope of work. Utility locations will be plotted in a client provided site drawing with clear, easy to read detail. Each utility is labeled and color coded in accordance with the indications marked in the field. We prepare CAD drawings to ensure the industry's most accurate drawings. The details of these drawings are based upon client specifications. Some of these options include depth, pipe diameter and materials, connection points, and all unknown utilities.

In addition to 36" x 24" prints, our drawings can also be saved in PDF format for simple distribution and viewing. Our detailed drawings can be used to provide designers and contractors with an overview of what to expect when performing site work. All mapping is done under the supervision of a licensed civil engineer.



ADDITIONAL SURVEYING SERVICES

In addition to mapping our utility location markings, we offer a full range of surveying services.



- ADA
- BOUNDARY
- A.L.T.A./N.S.P.S
- TOPOGRAPHIC
- CROSS-SECTIONS
- ENCUMBRANCE MAPS
- ORTHO AERIAL PHOTOS

EXCEPTIONS

Please be sure to provide any project documents prior to dispatch. A workable CAD file is required if mapping is to be performed. JPG, TIFF, PDF files are not preferred and may affect the quality of the final product. If no CAD file can be provided, additional costs may apply. A complete and editable background must be provided by the client to ensure the quality of the final product.





14280 Euclid Ave
Chino, CA 91710
1-888-90-BELOW
Fax: (909) 606-6555

POTHOLING

Potholing is also known as vacuum excavation and is used for the purpose of identifying the axis of an underground utility. When the utility is revealed, the type of material and utility size are documented. The data collected during these excavations are beneficial in all phases of construction. Based upon the soils conditions or scope, C Below will choose to use air or water to create the pothole. Potholes made to expose facilities encased in concrete, will stop at the encasement. The top of the encasement will then be recorded as the top of the facility.

After documenting our findings, each pothole will be backfilled, compacted, and a perm-a-patch or hot patch will be provided depending upon client specifications.

A potholing report complete with photographs are provided at the conclusion of the job documenting the location, utility found, depth to top of pipe, utility size, material and the soil conditions. If no utility is found within the predetermined depth of the pothole, it will be considered a dry hole. Additional holes may be necessary to provide a positive location of the utility.



C Below technicians performing potholing



Potholing equipment

PRICING & EXCEPTIONS

For billing purposes, C Below defines a standard pothole with the dimensions of 1' X 1' X 5' deep. Deviations from this standard definition require rate increases for additional time and materials to facilitate the client requests. Because potholing rates and other associated costs are based on the assumption of 8 hour work days, additional fees may apply if work is limited to less than 8 hours per day. These fees may include, but are not limited to: additional traffic control, travel time, and disposal fees. Standard pothole pricing includes holes at locations with a soil surface or an asphalt surface up to 6-inches thick. Additional fees will apply if the asphalt surface is over 6" thick or the proposed hole location has a concrete surface. If during the potholing operation the soil is found to have large aggregate or other debris over 3-inches in diameter, ground water, roots or hazardous materials, additional fees will apply. For further clarification please see rate sheet for 'Out of Scope Hole' and the table below. Optional Services include: hotpatching per City requirements, stamped traffic control plans by an engineer, routine traffic control plans.





14280 Euclid Ave
Chino, CA 91710
1-888-90-BELOW
Fax: (909) 606-6555

CCTV PIPE INSPECTION AND CRAWLER CAM

C Below provides video pipe inspection that will give vital information to help properly maintain utility and pipe facilities. We perform this service on sanitary sewer and storm drain lines specifically identified by the client or client's representative. CCTV pipe inspection includes trained personnel and the use of a push camera and/or crawler camera depending on the size of the line.

During this inspection, videos are recorded in full color MP4 files that can be viewed easily on all computers. Captions can be added to the video to help identify the technician findings. Our push cameras can video lines as small as 3" in diameter while our crawler cameras can do pipes upwards of 72". The video technology offers high quality assessment of all piping, including joints. We offer quick results with the ability to transfer video feed via USB and Bluetooth technology.

Standard details recorded during the inspection include: obstructions or blockages, root intrusion, structural damage, pipe offsets and flow conditions. Problem areas found will be identified on the surface for easy identification.

In the event that any blockage is found, we are able to provide water jetting to clear the obstructions. Sanitary Sewer and Storm Drain lines may contain debris and blockages that limit the ability to perform CCTV Pipe Inspection. C Below can arrange for an outside contractor to jet all lines prior to CCTV pipe inspection to ensure the full length of the pipe can be filmed.



CCTV Crawler Cam



Intact and damaged storm drains as recorded by our CCTV

EXCEPTIONS

All lines designated by the client for need of inspection must have clear unobstructed access points. Information gathered during the inspection must be agreed upon prior to dispatch. For added scope of water jetting additional fees apply

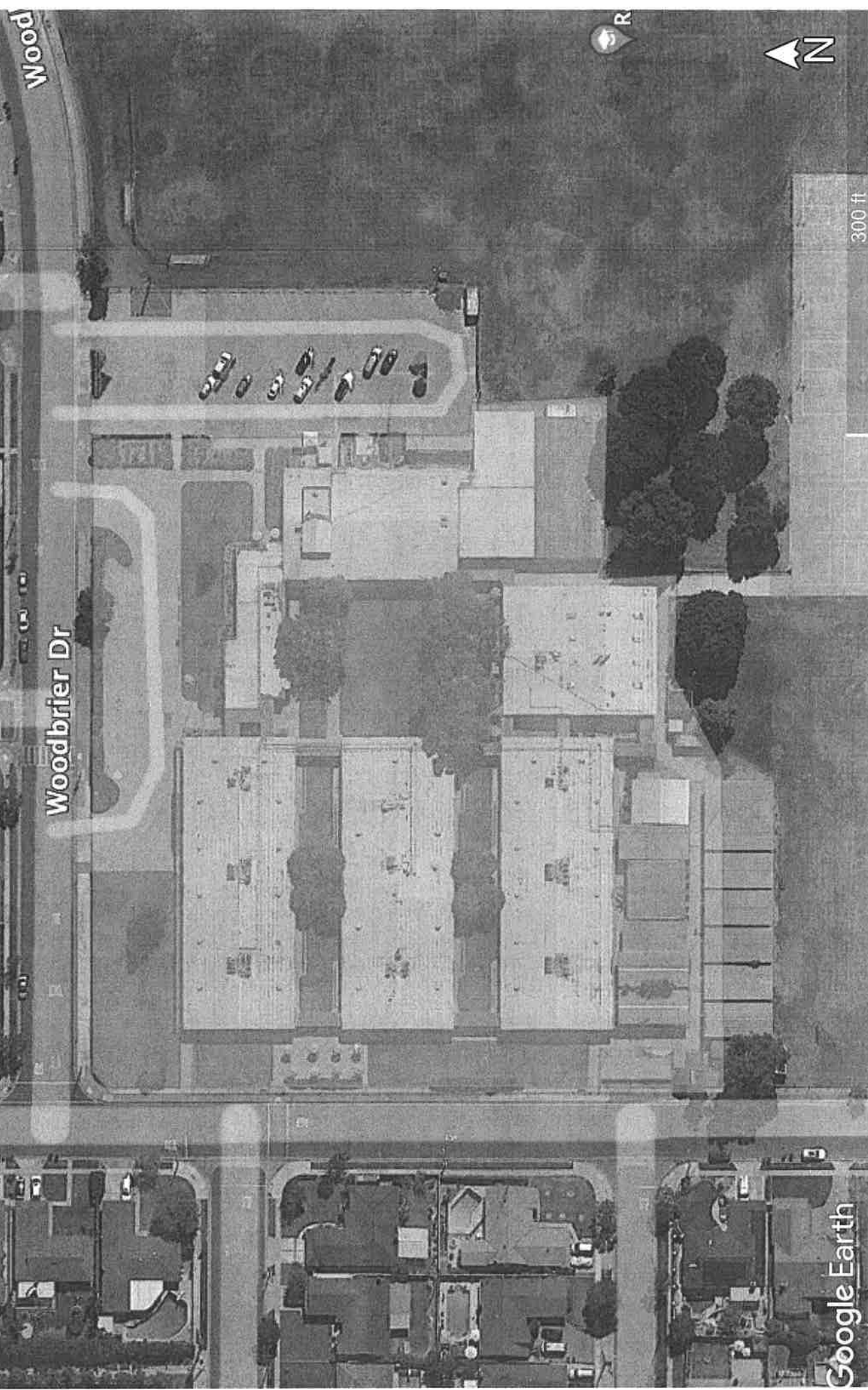

Exhibit A

Area of Investigation

Legend

📍 Woodbrier Dr



Google Earth

300 ft



Job 22-5479
Quote No. Q-14143
Date: 06-16-2022
Expires on: 07-16-2022
Payment Prevailing Wage | Net 30

Please review all pages in this agreement on our services capabilities and limitations before signing. Should you have any questions about our services, please contact your sales representative before signing this agreement.

Signature:

Effective Date:

Name (Print):

Title:

Client Billing Information

Bill to Name

Attention

Address

City

State

Zip

Email

C Below Signature:

Effective Date:

C Below Name (Print): Ashley Salvino

Title: Vice President of Operations

Please sign and email to Victoria Franco at victoriaf@cbelow.com.

After C Below receives this signed agreement, **Dispatch** will be notified immediately to begin the scheduling process. Service availability changes throughout the day. Service date and time can only be confirmed by dispatch after receiving this agreement.

THANK YOU FOR YOUR BUSINESS!



July 11, 2022

Lowell Joint School District
11019 Valley Home Avenue
Whittier, California 90603

Attn: Mr. David Bennett

Re: Meadow Green Elementary School
12025 Grovedale Drive, Admin Building, Various Areas
Whittier, California 90604

Dear Mr. Bennett,

Thank you for allowing A-Tech Consulting, Inc. (*A-Tech*) the opportunity to provide you with a cost proposal. This proposal is in response to your request that *A-Tech* conducts the Asbestos Project Monitoring and Asbestos Clearance Monitoring at the above referenced site.

The professional services provided by *A-Tech* will consist of the following:

ASBESTOS PROJECT MONITORING

- Full-time, on-site project observation of the project by a Cal-OSHA certified asbestos CSST or CAC, as required by law.
- Provide on-site air analysis (set up microscope on-site) per regulated area upon completion of removal and ensure that no fibers migrate from regulated areas.
- Air sample analysis to be performed by a NIOSH 582 Equivalency certified microscopist.
- Background, General and Clearance air sampling, in accordance with EPA protocols and analyzed by Phase Contrast Microscopy (PCM) using NIOSH 7400 "A" counting rules.
- Review and verification of asbestos abatement contractor's pre-project submittals (e.g. certifications, medical surveillance, SDS, respiratory protection plan, safety minutes, etc.) and act as a liaison between regulatory agencies, contractors and client.
- Closeout documentation detailing all abatement, monitoring and clearance results including air monitoring report and a clearance certificate OR clearance documentation including a clearance letter and air sampling logs.

ASBESTOS (TEM) CLEARANCE SAMPLING

- Visual clearance inspection of all completed abated areas. "White Glove" method clearance inspection will be conducted in accordance with AHERA regulations.
- Asbestos (TEM) clearance sampling by a state certified asbestos consultant or certified site surveillance technician, utilizing AHERA regulated sampling protocols.
- Samples to be collected by a high-volume air sampling pump calibrated with a rotameter, utilizing 25 mm MCE filters with pore size <0.45 microns utilizing aggressive air sampling (leaf blower and/or fans) protocol as required in the AHERA regulations.
- Analysis of samples by an NVLAP accredited laboratory, utilizing Transmission Electron Microscopy (TEM), in accordance with current AHERA/ASHARA regulatory requirements. The quoted sample analysis is based on 24 Hour laboratory analysis.
- Clearance documentation detailing all materials removed, locations of removal, air sampling logs and laboratory reports.



PRICING

Based on the information gathered, we propose to provide the following professional consulting services:

ASBESTOS PROJECT MONITORING AND ASBESTOS CLEARANCE

Item	Price		Qty	Line Total
Asbestos Project Monitoring, (8-Hour Shift)	\$1,250.00/Shift	X	3	\$3,750.00
Asbestos TEM Samples (TEM-AHERA)	\$145.00/Sample	X	5	\$725.00
			Total	\$4,475.00

I trust that this proposal will meet with your approval and look forward to working with you. Should you have any questions, please feel free to contact me at (714) 434-6360 office.

Sincerely,

A-Tech Consulting, Inc.

Joseph A. Williams, CAC, DPH
CAC #14-5269 DPH #19524

joew@atechinc.net

To proceed with scheduling, kindly reply to PM@atechinc.net and accounting@atechinc.net



Erickson-Hall Construction Co.
500 Corporate Drive
Escondido, California 92029
Phone: (760) 796-7700
Fax: (760) 796-7750

Project: 4204 - Meadow Green ES
12025 Grovedale Drive
Whittier, 90604

Prime Contract Change Order #002: Replace MSB per RFI 002 and RFI 006

TO:	Lowell Joint School District 11537 Grovedale Dr. Whittier, California 90604	FROM:	Erickson-Hall Construction Co 500 Corporate Drive Escondido, California 92029
PCCO NUMBER/REVISION:	002 / 0	CONTRACT FOR:	4204:Meadow Green ES Prime Contract
DATE CREATED:	7/21/2022	SUBMITTED DATE:	
SCHEDULE IMPACT:		TOTAL AMOUNT:	\$71,686.00

DESCRIPTION:
The following pricing is for replacing the existing main switchboard and installing a new Eaton switchboard per the response of RFI 002 and RFI 006. Included in the cost is the credit for the two breakers per E002, the demolition of the existing gear and the installation of the new switchboard. Excluded in the cost is the coordination with Southern California Edison and any changes associated with their design.

ATTACHMENTS:

Potential Change Orders in this Change Order

PCO #	Title	Schedule Impact	Amount
CO #2	Replace MSB per RFI 002 and RFI 006		\$71,686.00
Total:			\$71,686.00

The original (Contract Sum)	\$5,732,107.00
Net change by previously authorized Change Orders	\$94,950.00
The contract sum prior to this Change Order was	\$5,827,057.00
The contract sum would be changed by this Change Order in the amount of	\$71,686.00
The new contract sum including this Change Order will be	\$5,898,743.00

Execution of this Potential Change Order will revise the contract value as indicated and may change the contract duration. Contractor reserves it's right to request additional time and/or cost once the full extent or cumulative nature of the contract change(s) become known.

Ghataode Bannon Architects
760 W 16th Street Unit B
Costa Mesa, California 92627

Lowell Joint School District
11537 Grovedale Dr.
Whittier, California 90604

Erickson-Hall Construction Co
500 Corporate Drive
Escondido, California 92029

SIGNATURE **DATE**

SIGNATURE **DATE**

 7/21/2022
SIGNATURE **DATE**



PCO #CO #2

Erickson-Hall Construction Co.
 500 Corporate Drive
 Escondido, California 92029
 Phone: (760) 796-7700
 Fax: (760) 796-7750

Project: 4204 - Meadow Green ES
 12025 Grovedale Drive
 Whittier, 90604

Potential Change Order #CO #2: Replace MSB per RFI 002 and RFI 006

TO:	Lowell Joint School District 11537 Grovedale Dr. Whittier, California 90604	FROM:	Erickson-Hall Construction Co 500 Corporate Drive Escondido, California 92029
PCO NUMBER/REVISION:	CO #2 / 0	CONTRACT:	4204 - Meadow Green ES Prime Contract
REFERENCE:		SUBMITTED DATE:	
CHANGE TYPE:		SCHEDULE IMPACT:	

POTENTIAL CHANGE ORDER TITLE: Replace MSB per RFI 002 and RFI 006

POTENTIAL CHANGE ORDER DESCRIPTION:

Replace MSB per RFI 002 and RFI 006

The following pricing is for replacing the existing main switchboard and installing a new Eaton switchboard per the response of RFI 002 and RFI 006. Included in the cost is the credit for the two breakers per E002, the demolition of the existing gear and the installation of the new switchboard. Excluded in the cost is the coordination with Southern California Edison and any changes associated with their design.

ATTACHMENTS:

[4204 - Change Order #02 - Replace MSB per RFI 002 and RFI 006.pdf](#)

#	Cost Code	Description	Type	Amount
1	4204-01 - Electrical & FA	Furnish all labor and material to remove and replace a new switchboard per RFI 002 and RFI 006.	Commitment	\$67,596.00
2	100-00 - General Conditions	Contractor OH&P (5%)	Other	\$3,380.00
3	100-00 - General Conditions	Contractor Bond (1%)	Other	\$710.00
			Grand Total:	\$71,686.00

Ghataode Bannon Architects
 760 W 16th Street Unit B
 Costa Mesa, California 92627

Lowell Joint School District
 11537 Grovedale Dr.
 Whittier, California 90604

Erickson-Hall Construction Co
 500 Corporate Drive
 Escondido, California 92029

 SIGNATURE DATE SIGNATURE DATE SIGNATURE DATE



ERICKSON - HALL
CONSTRUCTION CO.

Change Order Proposal

School: Meadow Green Elementary School

Project Name: Meadow Green Elementary School - HVAC and REROOF
Project No.: 4204

DSA Application No.: 03-121823

Architect: Ghataode Bannon Architects.
Project Manager: Lowell Joint School District
Contractor: Erickson-Hall Construction Co.

COP No.: 2
Date: 7/21/2022
Reference RFIs: RFI 002 and 006
Reference RFP / Bulletin No.: N/A

DESCRIPTION: The following pricing is for replacing the existing main switchboard and installing a new Eaton switchboard per the response of RFI 002 and RFI 006. Included in the cost is the credit for the two breakers per E002, the demolition of the existing gear and the installation of the new switchboard. Excluded in the cost is the coordination with Southern California Edison and any changes associated with their design.

Subcontractor Costs (used when work is subcontracted)

Subcontractor	Description	Material	Labor	Equipment	Totals
Champion Electric, Inc.	Replace Existing Main Switchboard with New	\$ 50,688.45	\$ 9,004.72	\$ 1,150.00	\$ 60,843.17
					\$ -
					\$ -
					\$ -
					\$ -
	Subtotals	\$ 50,688.45	\$ 9,004.72	\$ 1,150.00	\$ 60,843.17
	Subcontractor OH and Profit (10%)				\$6,084.32
	Tired Subcontractor Cost				N/A
	Subcontractor Profit of Tired Subcontractor (5%)				N/A
	Subcontractor Bond (1%)				\$669.27
	Subcontractor Subtotal				\$67,596.76
	Contractor OH and Profit (5%)				\$3,379.84
	Contractor/Subcontractor Subtotal				\$70,976.60
	Contractor Bond (1%)				\$709.77
	Subcontractor Total + Contractor Mark-ups				\$71,686.37

Contractor Costs (used when work is self-performed)

Contractor	Description	Material	Labor	Equipment	Totals
					\$ -
					\$ -
					\$ -
	Subtotals	\$ -	\$ -	\$ -	\$ -
	Contractor OH and Profit (10%)				\$ -
	Contractor totals				\$ -
	Contractor Bond (1%)				\$ -
	Contractor Subtotal				\$ -

TOTAL COSTS FOR COP No. 2 \$ 71,686

Contractor Time

TOTAL TIME FOR COP No. 2 0 days

Contractor: Erickson-Hall Construction Co.
Submitted by _____

Date: _____

District Approval:
Signature _____

Date: _____



Champion Electric Inc.

3950 Garner Rd.
Riverside, CA 92501
Telephone: (951)-591-5374
Contact: Roger Hernandez
E-mail: Rhernandez@championelec.com

Erickson-Hall Construction Co.

500 Corporate Drive
Escondido, CA 92029
Telephone: 760-803-0077
Contact: Mike Arnold
E-mail: marnold@ericksonhall.com

COST PROPOSAL

CCN # PCO 004 - REPLACE MSB R1
Date: 7/7/2022
Project Name: Meadow Green
Page Number: 1

DETAILS OF PROPOSAL

Description of Work:

Demo existing main switchboard and replace with new Eaton Pow-R-Line Xpert Switchboard 1200A. This includes a \$1,900 credit for the 2 breakers that were to be replaced per the drawings.

This price is contingent on being able to reuse the existing conductors and any conduit going into the existing gear. If any conductors do not reach the new breakers, new conductors or splicing would be required.

This does not include any work or material that Edison may require.

Conditions:

Upon review of the above stated direction we have identified cost impacts that must be addressed. We are submitting this proposal for your acceptance in response to this direction. This proposal is valid for a period of ten (10) business days upon receipt. As part of this proposal a time extension of ten (10) working days are required to be added to our contract to mitigate impacts to the original contract schedule. If a time extension is not acceptable we reserve the right to void this proposal and resubmit a new cost that accounts for acceleration, trade stacking, delays and other issues as may be required. This proposal is based upon information provided by the owner to accomplish completion of this change and we accept no responsibility for inadequate engineering or incomplete information. Excluded from this quote is any demo, patching, repairing, and or painting of finished surfaces unless specifically stated otherwise. We reserve the right to re-evaluate this pricing if conditions or information changes from time of submission to notice to proceed. Upon acceptance of this proposal please expedite our notice to proceed so work may begin as soon as possible. Please contact the undersigned if there are any questions in regards to this proposal.

PROPOSAL TOTAL

\$67,596.00

Signature: _____

ITEMIZED BREAKDOWN

Description	Qty	Labor	Total Mat.	Total Hrs.
5/8x3 1/2" WEDGE ANCHO	16	25.00	25.92	4.00
1200A 4-SECT SERVICE S	1	40.00	0.00	40.00
DEMO SWITCHGEAR	1	40.00	0.00	40.00
Totals			25.92	84.00

SUMMARY

GENERAL MATERIALS		25.92
DISTRIBUTION		45,950.00
MATERIAL TAX	(@ 10.250 %)	4,712.53
TOTAL MATERIAL		50,688.45
JOURNEYMAN	(35.00 Hrs @ \$98.24)	3,438.40
FOREMAN	(54.00 Hrs @ \$103.08)	5,566.32
TOTAL LABOR		9,004.72
FORKLIFT (per Day)		1,150.00
TOTAL EQUIPMENT		1,150.00
MARKUP	(@ 10.000 %)	6,084.32
TOTAL MARKUP		6,084.32
SUB-TOTAL		66,927.49
Warranty 1% of Labor and Material	(@ 1.000 %)	669.27
FINAL ADJUSTMENT		-0.76
FINAL AMOUNT		\$67,596.00



REQUEST FOR INFORMATION

Erickson-Hall Construction Co.
500 Corporate Drive
Escondido, California 92029
Phone: (760) 796-7700
Fax: (760) 796-7750

Project: 4204 - Meadow Green ES
12025 Grovedale Drive
Whittier, 90604

HIGH PRIORITY

Panel Clarification

TO:	David Bannon (Ghataode Bannon Architects)	FROM:	Jourdan Thomas (Champion Electric Inc) 3950 Garner Road Riverside, California 92501
DATE INITIATED:	06/08/2022	STATUS:	Open
LOCATION:		DUE DATE:	06/15/2022
COST IMPACT:	TBD	SCHEDULE IMPACT:	TBD
DRAWING NUMBER:	E002, E002A	SPEC SECTION:	
LINKED DRAWINGS:		REFERENCE:	Gear Submittal (noted R&R); EHCC-2
RECEIVED FROM:	Jourdan Thomas (Champion Electric Inc)		

COPIES TO:

Mike Arnold (Erickson-Hall Construction Co), Kevin Cenicerros (Erickson-Hall Construction Co), Gissell Gonzalez (Ghataode Bannon Architects), Bob Lathrop Jr. (Erickson-Hall Construction Co), Ben Regalado (Ghataode Bannon Architects)

Question from Jourdan Thomas (Champion Electric Inc) at 10:13 AM on 06/08/2022

Pertaining to the previous Gear Submittal, a few panels require clarification. Panels LD and LE have different notes on new single sheet E002A, in contrast to original single line E002. Are these panels still to be replaced? Please advise.

In addition, panel PD5 has the same note of "Replace" on both single line sheets. However, sheet E002 also includes additional notes, "Provide circuit breaker and hardware" and Existing Main Service Gear to be Reused". Do changes need to be provided for panel PD5? Or does the information in the initial submittal suffice?

*Note: The comments from the initial submittal do not mention the above noted panels.

Attachments:

[RFI #6.pdf](#)

Awaiting an Official Response

All Replies:

Intent is to replace LD, LE, and PD5.

Replacement panels need to contain branch circuit breakers to match existing respective panels.

Provide changes as indicated within the "delta 1" clouded areas of attached Sheet E002A.

SZ / FBA Engineering 6-16-2022

DATE	
BY	
APP'D	
CHECKED	
DATE	

MEADOW GREEN ELEMENTARY SCHOOL
HYAC & ROOF UPGRADES
1205 GROVEDALE DR., WHITTIER, CA 90604
LOWELL JOHN SCHOOL DISTRICT

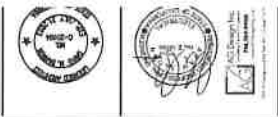

RRB CHARTRON HANNON ARCHITECTS
Architcture - Planning - Interior Design
1314 W. 15th Street, Suite 200
San Diego, CA 92101

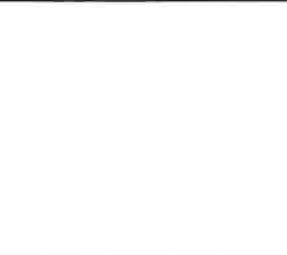

ELEVATION (E) MAIN SERVICE BOARD (MSB)

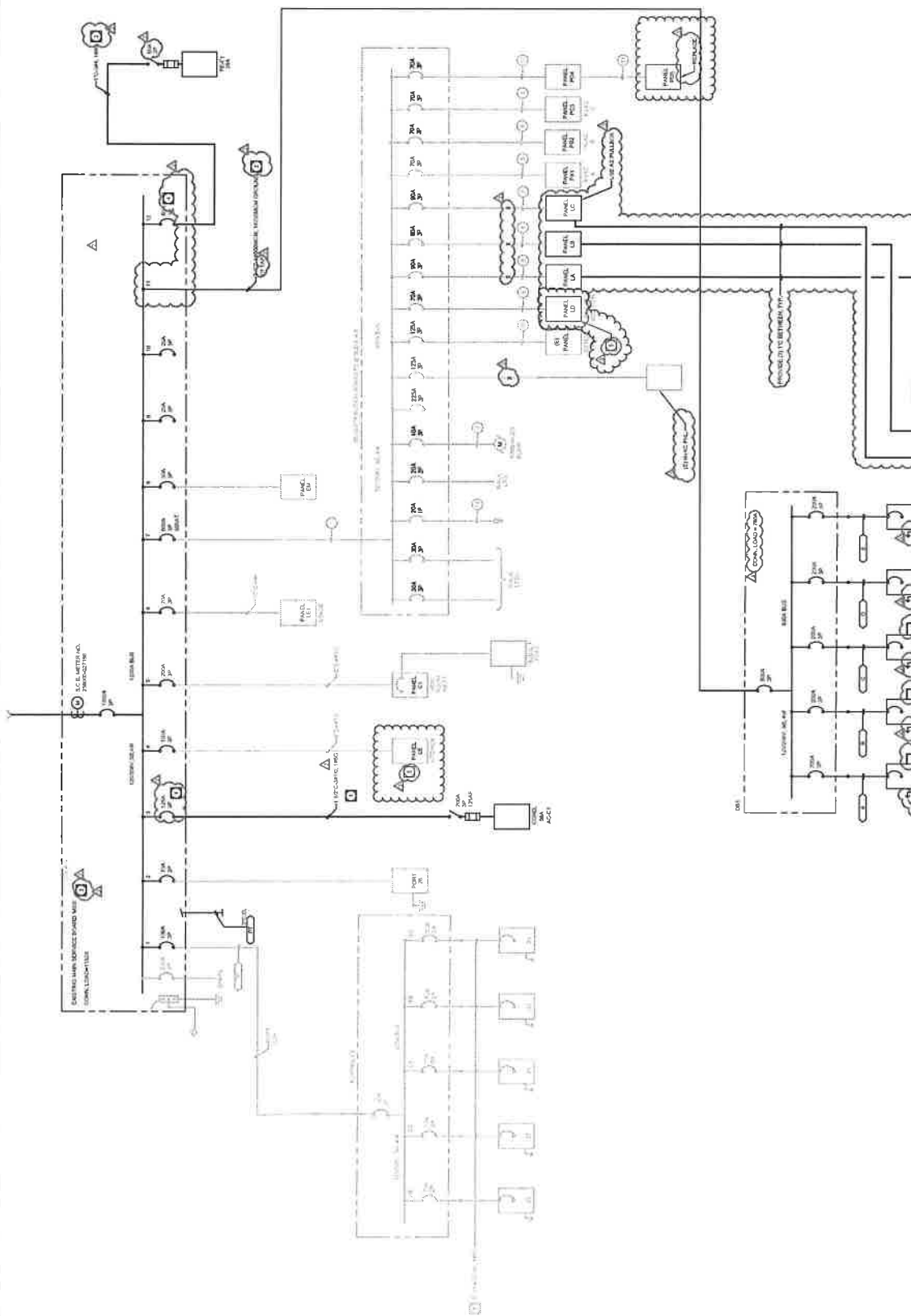

SINGLE-LINE DIAGRAM

SINGLE LINE NOTES

- 1. ALL PANELS SHALL BE PROVIDED WITH A BUSBARRIER FOR PROTECTION OF THE BUSBARS.
- 2. ALL PANELS SHALL BE PROVIDED WITH A BUSBARRIER FOR PROTECTION OF THE BUSBARS.
- 3. ALL PANELS SHALL BE PROVIDED WITH A BUSBARRIER FOR PROTECTION OF THE BUSBARS.
- 4. ALL PANELS SHALL BE PROVIDED WITH A BUSBARRIER FOR PROTECTION OF THE BUSBARS.
- 5. ALL PANELS SHALL BE PROVIDED WITH A BUSBARRIER FOR PROTECTION OF THE BUSBARS.
- 6. ALL PANELS SHALL BE PROVIDED WITH A BUSBARRIER FOR PROTECTION OF THE BUSBARS.
- 7. ALL PANELS SHALL BE PROVIDED WITH A BUSBARRIER FOR PROTECTION OF THE BUSBARS.
- 8. ALL PANELS SHALL BE PROVIDED WITH A BUSBARRIER FOR PROTECTION OF THE BUSBARS.
- 9. ALL PANELS SHALL BE PROVIDED WITH A BUSBARRIER FOR PROTECTION OF THE BUSBARS.
- 10. ALL PANELS SHALL BE PROVIDED WITH A BUSBARRIER FOR PROTECTION OF THE BUSBARS.

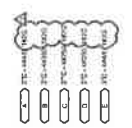

- ENTRANCE FEEDER SCHEDULE**
- 1. 2-200-1-CLASSROOM
 - 2. 2-200-2-CLASSROOM
 - 3. 2-200-3-CLASSROOM
 - 4. 2-200-4-CLASSROOM
 - 5. 2-200-5-CLASSROOM
 - 6. 2-200-6-CLASSROOM
 - 7. 2-200-7-CLASSROOM
 - 8. 2-200-8-CLASSROOM
 - 9. 2-200-9-CLASSROOM
 - 10. 2-200-10-CLASSROOM
 - 11. 2-200-11-CLASSROOM
 - 12. 2-200-12-CLASSROOM
 - 13. 2-200-13-CLASSROOM
 - 14. 2-200-14-CLASSROOM
 - 15. 2-200-15-CLASSROOM
 - 16. 2-200-16-CLASSROOM
 - 17. 2-200-17-CLASSROOM
 - 18. 2-200-18-CLASSROOM
 - 19. 2-200-19-CLASSROOM
 - 20. 2-200-20-CLASSROOM

SHOP DRAWING REVIEW COMMENTS

PROJECT: Meadow Green Elementary School
Lowell Joint School District
FBA #107512

SUBMITTAL: Submittal 26 06 25-1.0
Specification Section #260625
Distribution Switchboards

- I. Review of CONTRACTOR'S submittals is for general conformance with the design concept of the project and general compliance with the information given in the Contract Documents. Any action shown is subject to the requirements of the Plans and Specifications. CONTRACTOR is responsible for quantities; dimensions which shall be confirmed and correlated at the job site; fabrication processes and techniques of construction; coordination of work with that of all other trades and satisfactory performance of their work.*

REVIEW COMMENTS:

1. Distribution Panel DB1:
 - a. Change main circuit breaker and bus rating to 1000amp.
 - b. Change five 200 amp feeder circuit breakers to 250 amp.
2. Panel A:
 - a. Change bussing to 400 amp.
 - b. Change main circuit breaker to 250 amp.
 - c. Change 30A-3P branch circuit breaker at positions 37, 39, 41 to 40A-3P for service to HVAC unit AC-B8.
3. Panel B:
 - a. Change bussing to 400 amp.
 - b. Change main circuit breaker to 250 amp.
 - c. Change 30A-3P branch circuit breaker at positions 37, 39, 41 to 40A-3P for service to HVAC unit AC-B7.
4. Panel C:
 - a. Change bussing to 400 amp.
 - b. Change main circuit breaker to 250 amp.
5. Panel D:
 - a. Change bussing to 400 amp.
 - b. Change main circuit breaker to 250 amp.
 - c. Change 45A-3P branch circuit breaker at positions 1, 3, 5 to 50A-3P for service to HVAC unit AC-D1.
 - d. Change 45A-3P branch circuit breaker at positions 7, 9, 11 to 50A-3P for service to HVAC unit AC-D2.
 - e. Change 30A-3P branch circuit breaker at positions 19, 21, 23 to 40A-3P for service to HVAC unit AC-D4.
 - f. Change 30A-3P branch circuit breaker at positions 25, 27, 29 to 40A-3P for service to HVAC unit AC-D5.
 - g. Add 70A-3P branch circuit breaker (for backfeed connection to existing Panel LD per forthcoming change order)..

1075/012

6. Panel E:
- a. Change 30A-3P branch circuit breaker at positions 7, 9, 11 to 40A-3P for service to HVAC unit AC-E2.
 - b. Change 35A-3P branch circuit breaker at positions 20, 22, 24 to 40A-3P for service to HVAC unit AC-A1.
 - c. Delete 125A-3P circuit breaker serving Panel LK.
 - d. Delete 200A main circuit breaker and instead provide main lugs only.
 - e. Change all branch circuit breakers to type that is series rated with upstream feeder breaker for 42KAIC. (Upstream circuit breaker is in main switchboard and is part of forthcoming change order to replace main switchboard).
7. Amp ratings of safety switches shall be as required to accommodate fuse sizes indicated on nameplate of respective HVAC unit served.

--- End of Comments ---

CONTRACTOR ACTION:

- | | |
|---|--|
| <input type="checkbox"/> NO EXCEPTION TAKEN | <input checked="" type="checkbox"/> SEE COMMENTS ABOVE |
| <input type="checkbox"/> MAKE CORRECTIONS NOTED | <input type="checkbox"/> |
| <input type="checkbox"/> RESUBMITTAL NOT REQUIRED | <input checked="" type="checkbox"/> REVISE AND RESUBMIT AS NOTED |

**FBA Engineering
Consulting Electrical Engineers**

By: Stephen Zajicek PE

Date: May 25, 2022



GANTROPIC BROWN ARCHITECTS
 Architecture • Interior Design
 1414 N. GARDEN STREET, SUITE 200
 ANAHEIM, CA 92805
 (714) 771-1111

NOTES:

1. DISCONNECT AND REMOVE TESTING MECHANISM AND PROVIDE NEW SUPPLYING AT SAME LOCATION.
2. MAIN PANEL SECTION OF SWITCHBOARD.
3. REPROGRAM ALL SECTION OF SWITCHBOARD WITH TERMINATION FACILITIES AND BUSINESS FEEDBACK FOR REPAIRS/REPAIRS.
4. CHECK ALL SECTION OF SWITCHBOARD AND PROVIDE FOR OVERHEAD CONDUIT AND TERMINATION OF ALL FEEDS FROM PANEL POWER SYSTEM FEEDS LOCATED ELECTRICAL FEEDS OF MAIN PANEL.
5. CONDUCT ALL NECESSARY WORK TO DISCONNECT ALL FEEDS FROM MAIN PANEL AND TERMINATE ALL FEEDS TO MAIN PANEL.
6. REMOVE FEEDS FROM MAIN PANEL AND PROVIDE FOR OVERHEAD CONDUIT AND TERMINATION OF ALL FEEDS FROM PANEL POWER SYSTEM FEEDS LOCATED ELECTRICAL FEEDS OF MAIN PANEL.
7. VERIFY TERMINATION OF FEEDS TO MAIN PANEL WITH ALL FEEDS FROM MAIN PANEL AND PROVIDE FOR OVERHEAD CONDUIT AND TERMINATION OF ALL FEEDS FROM PANEL POWER SYSTEM FEEDS LOCATED ELECTRICAL FEEDS OF MAIN PANEL.
8. DISCONNECT AND REMOVE FEEDS FROM MAIN PANEL AND RECONNECT TO MAIN SWITCHBOARD.
9. PROVIDE TERMINATION FACILITIES FOR FEEDS FROM MAIN PANEL AND RECONNECT TO MAIN SWITCHBOARD.
10. DISCONNECT AND REMOVE FEEDS FROM MAIN PANEL AND RECONNECT TO MAIN SWITCHBOARD.
11. REMOVE CIRCUIT BREAKERS AND BUSBARS FROM MAIN PANEL AND PROVIDE FOR OVERHEAD CONDUIT AND TERMINATION OF ALL FEEDS FROM PANEL POWER SYSTEM FEEDS LOCATED ELECTRICAL FEEDS OF MAIN PANEL.
12. DISCONNECT AND REMOVE FEEDS FROM MAIN PANEL AND RECONNECT TO MAIN SWITCHBOARD.
13. VERIFY TERMINATION OF FEEDS TO MAIN PANEL WITH ALL FEEDS FROM MAIN PANEL AND PROVIDE FOR OVERHEAD CONDUIT AND TERMINATION OF ALL FEEDS FROM PANEL POWER SYSTEM FEEDS LOCATED ELECTRICAL FEEDS OF MAIN PANEL.
14. DISCONNECT AND REMOVE FEEDS FROM MAIN PANEL AND RECONNECT TO MAIN SWITCHBOARD.
15. PROVIDE TERMINATION FACILITIES FOR FEEDS FROM MAIN PANEL AND RECONNECT TO MAIN SWITCHBOARD.
16. DISCONNECT AND REMOVE FEEDS FROM MAIN PANEL AND RECONNECT TO MAIN SWITCHBOARD.
17. REMOVE CIRCUIT BREAKERS AND BUSBARS FROM MAIN PANEL AND PROVIDE FOR OVERHEAD CONDUIT AND TERMINATION OF ALL FEEDS FROM PANEL POWER SYSTEM FEEDS LOCATED ELECTRICAL FEEDS OF MAIN PANEL.
18. DISCONNECT AND REMOVE FEEDS FROM MAIN PANEL AND RECONNECT TO MAIN SWITCHBOARD.
19. VERIFY TERMINATION OF FEEDS TO MAIN PANEL WITH ALL FEEDS FROM MAIN PANEL AND PROVIDE FOR OVERHEAD CONDUIT AND TERMINATION OF ALL FEEDS FROM PANEL POWER SYSTEM FEEDS LOCATED ELECTRICAL FEEDS OF MAIN PANEL.
20. DISCONNECT AND REMOVE FEEDS FROM MAIN PANEL AND RECONNECT TO MAIN SWITCHBOARD.
21. PROVIDE TERMINATION FACILITIES FOR FEEDS FROM MAIN PANEL AND RECONNECT TO MAIN SWITCHBOARD.
22. DISCONNECT AND REMOVE FEEDS FROM MAIN PANEL AND RECONNECT TO MAIN SWITCHBOARD.
23. REMOVE CIRCUIT BREAKERS AND BUSBARS FROM MAIN PANEL AND PROVIDE FOR OVERHEAD CONDUIT AND TERMINATION OF ALL FEEDS FROM PANEL POWER SYSTEM FEEDS LOCATED ELECTRICAL FEEDS OF MAIN PANEL.
24. DISCONNECT AND REMOVE FEEDS FROM MAIN PANEL AND RECONNECT TO MAIN SWITCHBOARD.
25. VERIFY TERMINATION OF FEEDS TO MAIN PANEL WITH ALL FEEDS FROM MAIN PANEL AND PROVIDE FOR OVERHEAD CONDUIT AND TERMINATION OF ALL FEEDS FROM PANEL POWER SYSTEM FEEDS LOCATED ELECTRICAL FEEDS OF MAIN PANEL.
26. DISCONNECT AND REMOVE FEEDS FROM MAIN PANEL AND RECONNECT TO MAIN SWITCHBOARD.
27. PROVIDE TERMINATION FACILITIES FOR FEEDS FROM MAIN PANEL AND RECONNECT TO MAIN SWITCHBOARD.

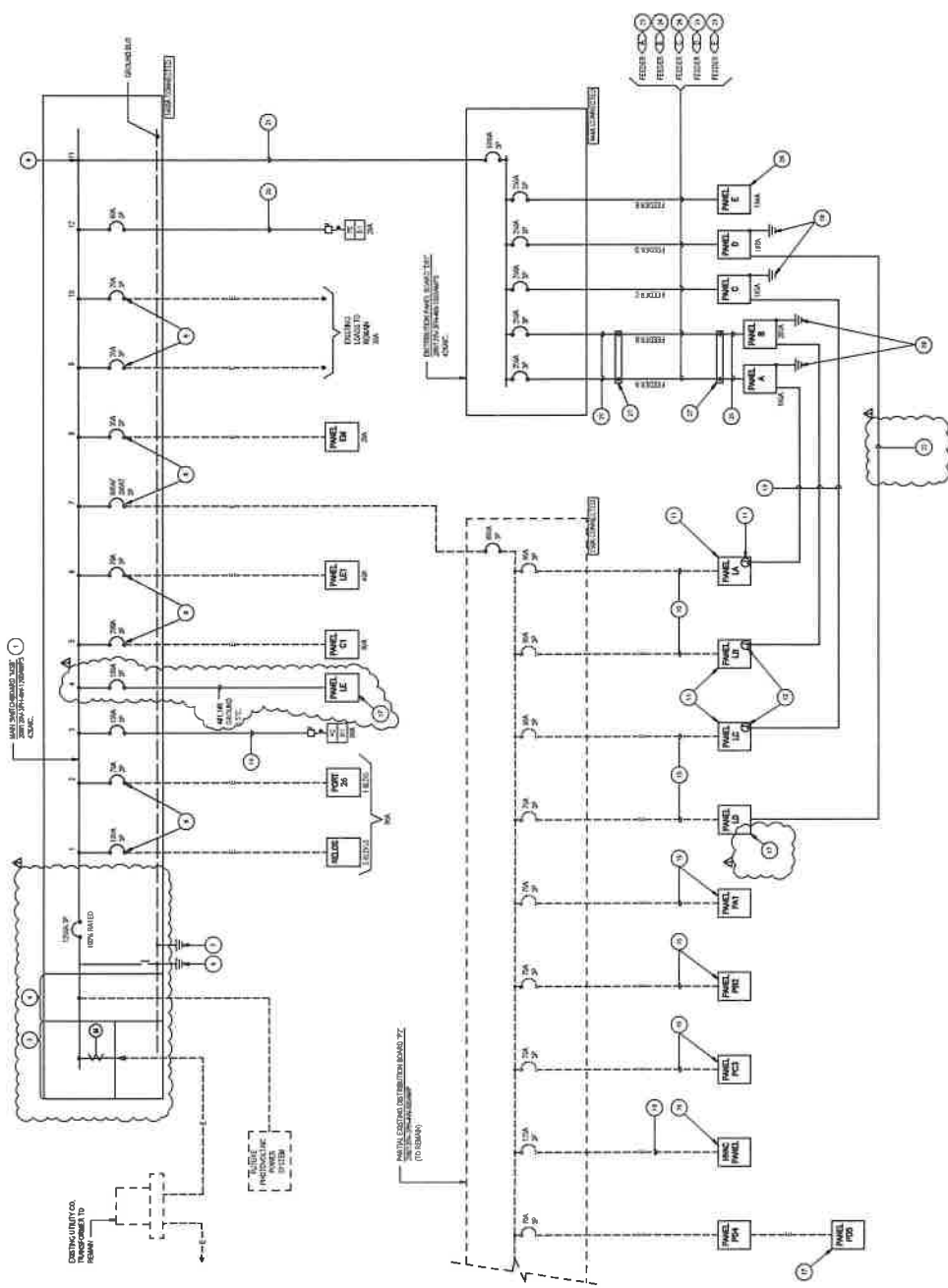

SEE SHEET FOR PANEL CONNECTIONS TO MAIN PANEL AND DISTRIBUTION

LOAD SUMMARY
 TOTAL LOAD: 2000 KW
 MAXIMUM LOAD: 2000 KW
 CONNECTED LOAD: 2000 KW
 DEMAND FACTOR: 0.8
 SERVICE FACTOR: 1.0
 SERVICE FACTOR: 1.0



REQUEST FOR INFORMATION

Erickson-Hall Construction Co.
500 Corporate Drive
Escondido, California 92029
Phone: (760) 796-7700
Fax: (760) 796-7750

Project: 4204 - Meadow Green ES
12025 Grovedale Drive
Whittier, 90604

Circuit Breakers Loads

TO:	David Bannon (Ghataode Bannon Architects)	FROM:	Christian Mejia (Erickson-Hall Construction Co) 500 Corporate Drive Escondido, California 92029
DATE INITIATED:	05/12/2022	STATUS:	Open
LOCATION:		DUE DATE:	05/19/2022
COST IMPACT:	TBD	SCHEDULE IMPACT:	TBD
DRAWING NUMBER:	E002, E002	SPEC SECTION:	26 00 00 - GENERAL ELECTRICAL SPECIFICATIONS
LINKED DRAWINGS:		REFERENCE:	
RECEIVED FROM:	Mike Arnold (Erickson-Hall Construction Co)		
COPIES TO:	Mike Arnold (Erickson-Hall Construction Co), Kevin Cenicerros (Erickson-Hall Construction Co), Gissell Gonzalez (Ghataode Bannon Architects), Bob Lathrop Jr. (Erickson-Hall Construction Co), Ben Regalado (Ghataode Bannon Architects)		

Question from Christian Mejia (Erickson-Hall Construction Co) at 07:05 AM on 05/12/2022

Please confirm that the breakers size and wires gauge size are capable to carry the load for the HVAC units for Buildings A-B, C, D and E.

Attachments:
[RFI #002.pdf](#)

Awaiting an Official Response

All Replies:

Please refer to shop drawing review comments for 26 06 25-1 Distribution Switchboards dated 5/25/2022 and revised single-line diagram scheduled to be issued 5/31/2022.

D.Bannon
5/27/2022

SHOP DRAWING REVIEW COMMENTS

PROJECT: Meadow Green Elementary School
Lowell Joint School District
FBA #107512

SUBMITTAL: Submittal 26 06 25-1.0
Specification Section #260625
Distribution Switchboards

- i. *Review of CONTRACTOR'S submittals is for general conformance with the design concept of the project and general compliance with the information given in the Contract Documents. Any action shown is subject to the requirements of the Plans and Specifications. CONTRACTOR is responsible for quantities; dimensions which shall be confirmed and correlated at the job site; fabrication processes and techniques of construction; coordination of work with that of all other trades and satisfactory performance of their work.*

REVIEW COMMENTS:

1. Distribution Panel DB1:
 - a. Change main circuit breaker and bus rating to 1000amp.
 - b. Change five 200 amp feeder circuit breakers to 250 amp.

2. Panel A:
 - a. Change bussing to 400 amp.
 - b. Change main circuit breaker to 250 amp.
 - c. Change 30A-3P branch circuit breaker at positions 37, 39, 41 to 40A-3P for service to HVAC unit AC-B8.

3. Panel B:
 - a. Change bussing to 400 amp.
 - b. Change main circuit breaker to 250 amp.
 - c. Change 30A-3P branch circuit breaker at positions 37, 39, 41 to 40A-3P for service to HVAC unit AC-B7.

4. Panel C:
 - a. Change bussing to 400 amp.
 - b. Change main circuit breaker to 250 amp.

5. Panel D:
 - a. Change bussing to 400 amp.
 - b. Change main circuit breaker to 250 amp.
 - c. Change 45A-3P branch circuit breaker at positions 1, 3, 5 to 50A-3P for service to HVAC unit AC-D1.
 - d. Change 45A-3P branch circuit breaker at positions 7, 9, 11 to 50A-3P for service to HVAC unit AC-D2.
 - e. Change 30A-3P branch circuit breaker at positions 19, 21, 23 to 40A-3P for service to HVAC unit AC-D4.
 - f. Change 30A-3P branch circuit breaker at positions 25, 27, 29 to 40A-3P for service to HVAC unit AC-D5.
 - g. Add 70A-3P branch circuit breaker (for backfeed connection to existing Panel LD per forthcoming change order)..

1075/012

6. Panel E:
- a. Change 30A-3P branch circuit breaker at positions 7, 9, 11 to 40A-3P for service to HVAC unit AC-E2.
 - b. Change 35A-3P branch circuit breaker at positions 20, 22, 24 to 40A-3P for service to HVAC unit AC-A1.
 - c. Delete 125A-3P circuit breaker serving Panel LK.
 - d. Delete 200A main circuit breaker and instead provide main lugs only.
 - e. Change all branch circuit breakers to type that is series rated with upstream feeder breaker for 42KAIC. (Upstream circuit breaker is in main switchboard and is part of forthcoming change order to replace main switchboard).
7. Amp ratings of safety switches shall be as required to accommodate fuse sizes indicated on nameplate of respective HVAC unit served.

--- End of Comments ---

CONTRACTOR ACTION:

NO EXCEPTION TAKEN

MAKE CORRECTIONS NOTED

RESUBMITTAL NOT REQUIRED

SEE COMMENTS ABOVE

REVISE AND RESUBMIT AS NOTED

**FBA Engineering
Consulting Electrical Engineers**

By: Stephen Zajicek PE

Date: May 25, 2022

MEADOW GREEN ELEMENTARY SCHOOL
 HVAC & ROOF UPGRADES

12723 GROVEDALE PI., WHITTIER, CA 90604
 LOWELL JOINT SCHOOL DISTRICT

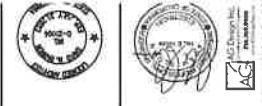

SHARON BARNUM ARCHITECTS
 Architecture • Planning • Interior Design
 10000 W. 116th St., Suite 100, Los Alamitos, CA 92653
 (714) 941-1161

- REVISIONS:
- 1. APPROVED
 - 2. APPROVED
 - 3. APPROVED
 - 4. APPROVED
 - 5. APPROVED
 - 6. APPROVED
 - 7. APPROVED
 - 8. APPROVED
 - 9. APPROVED
 - 10. APPROVED
 - 11. APPROVED
 - 12. APPROVED
 - 13. APPROVED
 - 14. APPROVED
 - 15. APPROVED
 - 16. APPROVED
 - 17. APPROVED
 - 18. APPROVED
 - 19. APPROVED
 - 20. APPROVED

SINGLE LINE NOTES

1. ALL ELECTRICAL WORK SHALL BE IN ACCORDANCE WITH THE 2008 NATIONAL ELECTRICAL CODE (NEC) AND THE 2008 CALIFORNIA ELECTRICAL CODE (CEC).

2. ALL ELECTRICAL WORK SHALL BE PERFORMED BY A LICENSED ELECTRICIAN OR UNDER HIS CLOSE PERSONAL SUPERVISION.

3. ALL ELECTRICAL WORK SHALL BE PERFORMED IN ACCORDANCE WITH THE MANUFACTURER'S INSTRUCTIONS.

4. ALL ELECTRICAL WORK SHALL BE PERFORMED IN ACCORDANCE WITH THE LOCAL ELECTRICAL CODES.

5. ALL ELECTRICAL WORK SHALL BE PERFORMED IN ACCORDANCE WITH THE LOCAL PERMITS.

6. ALL ELECTRICAL WORK SHALL BE PERFORMED IN ACCORDANCE WITH THE LOCAL INSPECTION REQUIREMENTS.

7. ALL ELECTRICAL WORK SHALL BE PERFORMED IN ACCORDANCE WITH THE LOCAL SAFETY REQUIREMENTS.

8. ALL ELECTRICAL WORK SHALL BE PERFORMED IN ACCORDANCE WITH THE LOCAL ENVIRONMENTAL REQUIREMENTS.

9. ALL ELECTRICAL WORK SHALL BE PERFORMED IN ACCORDANCE WITH THE LOCAL HISTORIC PRESERVATION REQUIREMENTS.

10. ALL ELECTRICAL WORK SHALL BE PERFORMED IN ACCORDANCE WITH THE LOCAL ARCHITECTURAL REQUIREMENTS.

11. ALL ELECTRICAL WORK SHALL BE PERFORMED IN ACCORDANCE WITH THE LOCAL LANDMARK REQUIREMENTS.

12. ALL ELECTRICAL WORK SHALL BE PERFORMED IN ACCORDANCE WITH THE LOCAL CULTURAL HERITAGE REQUIREMENTS.

13. ALL ELECTRICAL WORK SHALL BE PERFORMED IN ACCORDANCE WITH THE LOCAL HISTORIC DISTRICT REQUIREMENTS.

14. ALL ELECTRICAL WORK SHALL BE PERFORMED IN ACCORDANCE WITH THE LOCAL MONUMENT REQUIREMENTS.

15. ALL ELECTRICAL WORK SHALL BE PERFORMED IN ACCORDANCE WITH THE LOCAL NATIONAL HISTORIC LANDMARK REQUIREMENTS.

16. ALL ELECTRICAL WORK SHALL BE PERFORMED IN ACCORDANCE WITH THE LOCAL NATIONAL MONUMENT REQUIREMENTS.

17. ALL ELECTRICAL WORK SHALL BE PERFORMED IN ACCORDANCE WITH THE LOCAL NATIONAL HISTORIC LANDMARK DISTRICT REQUIREMENTS.

18. ALL ELECTRICAL WORK SHALL BE PERFORMED IN ACCORDANCE WITH THE LOCAL NATIONAL MONUMENT DISTRICT REQUIREMENTS.

19. ALL ELECTRICAL WORK SHALL BE PERFORMED IN ACCORDANCE WITH THE LOCAL NATIONAL HISTORIC LANDMARK DISTRICT MONUMENT REQUIREMENTS.

20. ALL ELECTRICAL WORK SHALL BE PERFORMED IN ACCORDANCE WITH THE LOCAL NATIONAL MONUMENT DISTRICT LANDMARK REQUIREMENTS.

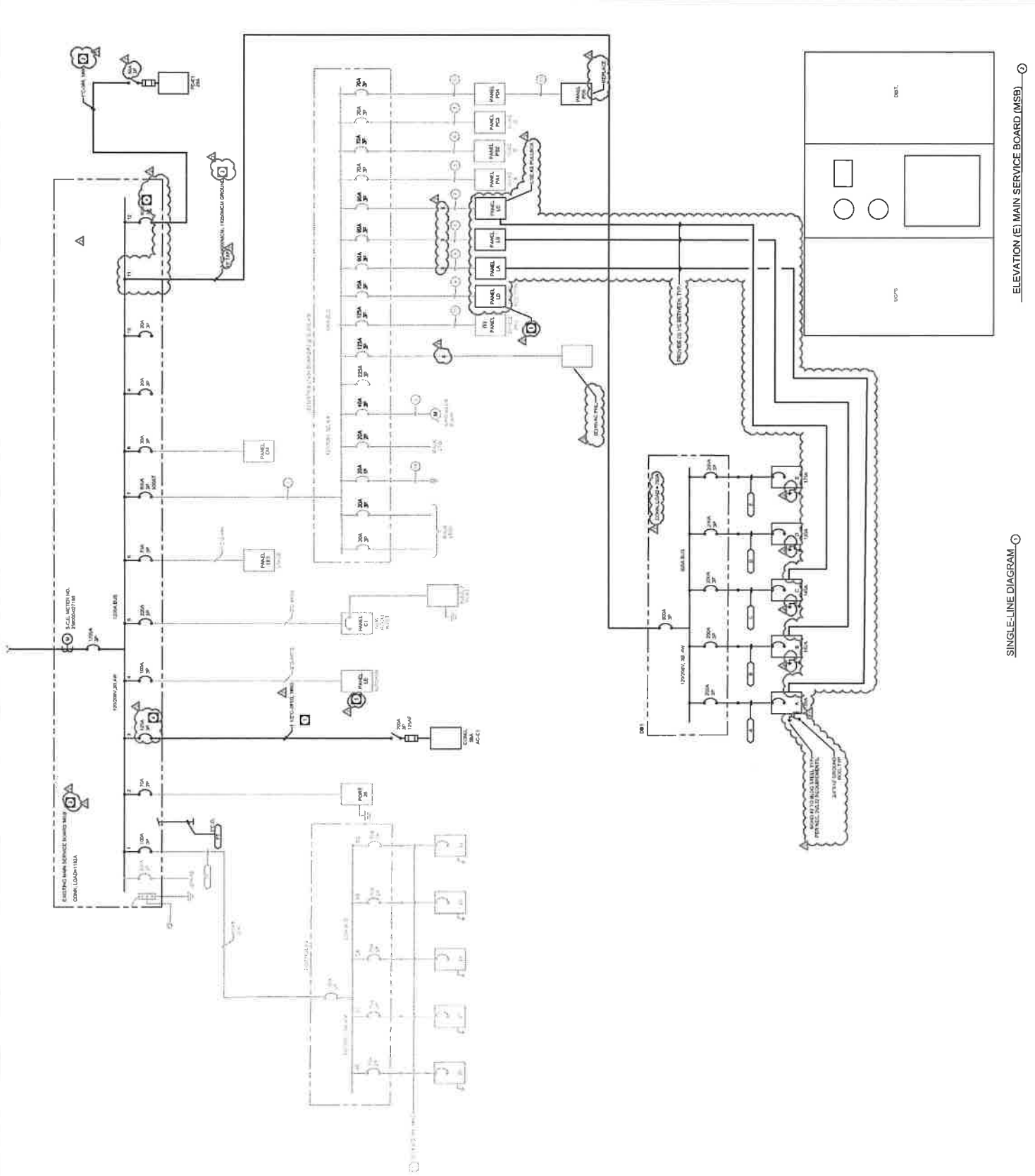

SINGLE-LINE DIAGRAM

ELEVATION (E) MAIN SERVICE BOARD (MSB)



Project No: 21-0851-0

June 24, 2022

Lowell Joint School District
11537 Grovedale Dr
Whittier, CA 90604

Attention: David Bennett

Subject: Change Order Proposal to complete Inspection and Testing Services
Jordan Elementary School 03-121043
10654 Jordan Rd
Whittier, CA

We have prepared this change order to request a contract modification to complete our scope on the Jordan Elementary School HVAC, Roofing, Fire Alarm & (N) Modular Buildings project. Due to additional work that will exceed RMA Group's original scope of work amount, RMA Group will need to perform the following additional work that remains on the project

SCOPE OF WORK

Our scope of work will consist of the following:

Earthwork Monitoring and Testing
Special Inspection and Testing of Masonry

We propose to perform these services on an hourly or test rate basis in accordance to the unit cost contained in the current active master agreement, for an additional estimated amount of \$10,452.00. This will increase the total contract from \$115,864.00 to \$126,316.00. In witness thereof, the parties have caused this agreement to be duly executed the day and year first above written.

CLIENT

By: _____

Title: _____

Date: _____

RMA Group

 _____

Prisila Neri
Title: Project Manager



ESTIMATE WORKSHEET

Compaction Testing of Trench Backfill

Item	Quantity	Unit	Unit Price	Total
Soils Engineering Technician	24	HR	\$94.50	\$2,268.00
	Subtotal:			\$2,268.00

ESTIMATE WORKSHEET

Structural Steel Shop and Field Welding

Item	Quantity	Unit	Unit Price	Total
AWS Certified Welding Inspector- Field	52	HR	\$94.50	\$4,914.00
AWS Certified Welding Inspector- Shop	20	HR	\$94.50	\$1,890.00
	Subtotal:			\$6,804.00

ESTIMATE WORKSHEET

Project Administration, Engineering Oversight, and Reporting

Item	Quantity	Unit	Unit Price	Total
Project Manager - Office	2	HR	\$155.00	\$310.00
Project Engineer - Office	4	HR	\$170.00	\$680.00
Administrative	2	HR	\$60.00	\$120.00
Staff Engineer - Office	2	HR	\$135.00	\$270.00
	Subtotal:			\$1,380.00

LOWELL JOINT SD
PURCHASE ORDER DETAIL REPORT
 BOARD OF TRUSTEES MEETING 08/08/2022

FROM 06/01/2022 TO 06/30/2022

PO NUMBER	VENDOR	PO TOTAL	ACCOUNT AMOUNT	ACCOUNT NUMBER	PSEUDO / OBJECT DESCRIPTION
R99A0016	OCDE	4,200.00	4,200.00	0174250056 5800	EL0#2-LG5A1 / Prof/ConsultingServ&Oper Exp
R99B0045	KING OFFICE SERVICES	16,500.00	16,500.00	2100000011 6282	BF-Unrest-Not Applicable / Consultant/Contractor
R99B0046	DIVISION OF THE STATE ARCHITECT	9,140.00	9,140.00	2100000015 6217	BF-Unrest-Not Applicable / DSA Fees
R99F0138	PDDQ EQUIPMENT RENTAL	330.00	330.00	0100000098 5610	GF-Unrest-Not Applicable / Rentals & Leases
R99F0139	ORBIT EVENT RENTALS	3,610.00	3,610.00	0100000094 4300	GF-Unrest-Not Applicable / Materials and Supplies
R99F0140	ICSS SERVICE COMPANY	1,819.10	403.50	0100000089 5630	GF-Unrest-Not Applicable / Repairs or Maintenance
			240.00	0100000090 5630	GF-Unrest-Not Applicable / Repairs or Maintenance
			455.60	0100000091 5630	GF-Unrest-Not Applicable / Repairs or Maintenance
			240.00	0100000093 5630	GF-Unrest-Not Applicable / Repairs or Maintenance
			480.00	0100000096 5630	GF-Unrest-Not Applicable / Repairs or Maintenance
R99F0141	EAST WHITTIER GLASS & MIRROR	175.00	175.00	0100000093 5630	GF-Unrest-Not Applicable / Repairs or Maintenance
R99F0142	EAST WHITTIER GLASS & MIRROR	200.00	200.00	0100000093 5630	GF-Unrest-Not Applicable / Repairs or Maintenance
R99F0143	F.M. THOMAS AIR CONDITIONING	5,945.14	5,945.14	0100000094 5630	GF-Unrest-Not Applicable / Repairs or Maintenance
R99F0144	F.M. THOMAS AIR CONDITIONING	1,432.44	1,432.44	0100000094 5630	GF-Unrest-Not Applicable / Repairs or Maintenance
R99F0145	BUG FLIP	215.00	100.00	0100000121 5570	GF-Unrestricted / Pest Control
			60.00	0100000138 5570	GF-Unrestricted / Pest Control
			30.00	0100000141 5570	GF-Unrestricted / Pest Control
			25.00	0100000142 5570	GF-Unrestricted / Pest Control
R99F0146	CANNINGS HARDWARE LA HABRA	74.56	74.56	0100000098 4300	GF-Unrest-Not Applicable / Materials and Supplies
R99F0147	CINTAS FIRE PROTECTION	471.34	235.67	0100000092 5630	GF-Unrest-Not Applicable / Repairs or Maintenance
			235.67	0100000094 5630	GF-Unrest-Not Applicable / Repairs or Maintenance
R99F0148	GLASBY MAINTENANCE SUPPLY	20,566.66	2,893.88	0185100004 4300	RRMA-Cust/Jordan / Materials and Supplies
			4,125.15	0185100005 4300	RRMA-Cust/Macy / Materials and Supplies
			465.13	0185100007 4300	RRMA-Cust/Olita / Materials and Supplies
			7,132.14	0185100008 4300	RRMA-Cust/RS / Materials and Supplies
			4,515.82	0185100022 4300	RRMA-Custodial/Maybrook / Materials and Supplies

LOWELL JOINT SD

PURCHASE ORDER DETAIL REPORT

BOARD OF TRUSTEES MEETING 08/08/2022

FROM 06/01/2022 TO 06/30/2022

PO NUMBER	VENDOR	PO TOTAL	ACCOUNT AMOUNT	ACCOUNT NUMBER	PSEUDO / OBJECT DESCRIPTION
R99F0148	*** CONTINUED ***		1,434.54	1851000003 4300	RRMA-Cust/EP / Materials and Supplies
R99F0149	F.M. THOMAS AIR CONDITIONING	4,142.49	4,142.49	0100000094 5630	GF-Unrest-Not Applicable / Repairs or Maintenance
R99F0150	AMERICAN TIME	218.99	218.99	0100000098 4300	GF-Unrest-Not Applicable / Materials and Supplies
R99F0151	BUG FLIP	120.00	90.00	0100000105 5570	GF-Unrest-Not Applicable / Pest Control
			30.00	0100000106 5570	GF-Unrest-Not Applicable / Pest Control
R99F0152	THE SHERWIN-WILLIAMS CO.	1,001.37	1,001.37	0100000098 4300	GF-Unrest-Not Applicable / Materials and Supplies
R99F0153	THE SHERWIN-WILLIAMS CO.	10,771.42	10,771.42	4000000027 6400	CapAssv/Fac&Ops / Equipment
R99F0154	SOUTHEAST CONSTRUCTION PRODUCT	40.68	18.25	0100000090 4300	GF-Unrest-Not Applicable / Materials and Supplies
			22.43	0100000098 4300	GF-Unrest-Not Applicable / Materials and Supplies
R99F0155	LOWES	16.44	16.44	0100000095 4300	GF-Unrest-Not Applicable / Materials and Supplies
R99F0156	CITY OF LA HABRA	2,865.51	2,048.93	0100000098 4360	GF-Unrest-Not Applicable / Tires, Fuel and Oil
			816.58	0100000108 4360	GF-Unrest-Not Applicable / Tires, Fuel and Oil
R99F0157	THE HOME DEPOT PRO INSTITUTION	2,972.03	64.66	0100000090 4300	GF-Unrest-Not Applicable / Materials and Supplies
			1,043.83	0100000094 4300	GF-Unrest-Not Applicable / Materials and Supplies
			1,863.54	0100000098 4300	GF-Unrest-Not Applicable / Materials and Supplies
R99F0158	WALTERS WHOLESALE ELECTRIC	2,634.91	100.85	0100000093 4300	GF-Unrest-Not Applicable / Materials and Supplies
			2,534.06	0100000098 4300	GF-Unrest-Not Applicable / Materials and Supplies
R99M0250	AMERICAN EXPRESS	457.46	457.46	0108880020 4300	GF-Technology-Not Applicable / Materials and Supplies
R99M0254	AMERICAN EXPRESS	189.63	189.63	01051110043 4300	ClisAdmnRS-LCAP G1/A8 / Materials and Supplies
R99M0255	AMERICAN EXPRESS	429.92	429.92	010880006 4300	GF-TechAllocMG / Materials and Supplies
R99M0256	AMERICAN EXPRESS	2,841.60	2,841.60	0140350029 5200	TII-EdServ-G4A1 / Travel and Conferences
R99M0257	AMERICAN EXPRESS	94,798.84	94,798.84	0163000002 4130	GF-Lottery-Not Applicable / Textbooks
R99M0258	AMERICAN EXPRESS	120.00	120.00	0140350029 5200	TII-EdServ-G4A1 / Travel and Conferences

LOWELL JOINT SD
PURCHASE ORDER DETAIL REPORT
 BOARD OF TRUSTEES MEETING 08/08/2022

FROM 06/01/2022 TO 06/30/2022

<u>PO NUMBER</u>	<u>VENDOR</u>	<u>PO TOTAL</u>	<u>ACCOUNT AMOUNT</u>	<u>ACCOUNT NUMBER</u>	<u>PSEUDO / OBJECT DESCRIPTION</u>
R99R0473	FULLERTON JOINT UNION HS DIST	1,161.00	1,161.00	2500000014 5800	DM-Unrest-NotApplic / Prof/ConsultingServ&Oper Exp
R99R0474	LUX BUS AMERICA	1,000.00	1,000.00	0105110036 4300	GF-SiteAllocRS-LCAPGL1-Act8 / Materials and Supplies
R99R0475	COLLEGE BOARD	2,091.00	2,091.00	0105110043 4300	ClsAdmnRS-LCAP G1/A8 / Materials and Supplies
R99R0476	BUENA PARK PLAQUE & TROPHY	80.81	80.81	0100000317 4300	GF_UNRESTRICTED_SUPT / Materials and Supplies
R99R0477	PARENTPOWERED PBC	1,745.00	1,745.00	0190200006 5810	EarlyLitL-G2A4 / Licenses/Technology
R99R0478	WALTERS WHOLESALE ELECTRIC	2,493.04	2,336.46	0100000098 4300	GF-Unrest-Not Applicable / Materials and Supplies
			156.58	0100000098 4380	GF-Unrest-Not Applicable / Tools/M&O
R99R0479	HEAR NOW	407.93	407.93	016500063 5850	GF-SPECIAL ED / Conslt/Ind Contractors(NonEmp)
R99R0480	TRINIDAD, GINA	617.58	617.58	0105110043 4300	ClsAdmnRS-LCAP G1/A8 / Materials and Supplies
R99R0481	GLASBY MAINTENANCE SUPPLY	14,038.17	3,102.96	0185100004 4300	RRMA-Cust/Jordan / Materials and Supplies
			2,396.39	0185100005 4300	RRMA-Cust/Macy / Materials and Supplies
			1,315.93	0185100006 4300	RRMA-Cust/MG / Materials and Supplies
			869.09	0185100007 4300	RRMA-Cust/Olita / Materials and Supplies
			900.69	0185100008 4300	RRMA-Cust/RS / Materials and Supplies
			3,588.70	0185100009 4300	RRMA-Cust/D.O. / Materials and Supplies
			670.49	0185100022 4300	RRMA-Custodial/Maybrook / Materials and Supplies
			1,193.92	1851000003 4300	RRMA-Cust/EP / Materials and Supplies
R99R0482	SPORTS JACKETS UNLIMITED	460.85	460.85	0100000317 4300	GF_UNRESTRICTED_SUPT / Materials and Supplies
R99R0483	J.W.PEPPER & SON INC.	280.01	280.01	0105110036 4300	GF-SiteAllocRS-LCAPGL1-Act8 / Materials and Supplies
R99R0484	LA HABRA AREA CHAMBER OF COMME	150.00	150.00	0100000317 4300	GF_UNRESTRICTED_SUPT / Materials and Supplies
R99R0485	IMPERIAL BAND INSTRUMENTS	686.32	176.32	0105110041 4300	GF-SiteAllocRS / Materials and Supplies
			510.00	0105110041 5630	GF-SiteAllocRS / Repairs or Maintenance
R99R0486	IMPERIAL BAND INSTRUMENTS	165.49	65.49	0105110041 4300	GF-SiteAllocRS / Materials and Supplies
			100.00	0105110041 5630	GF-SiteAllocRS / Repairs or Maintenance
R99R0487	INLAND EMPIRE TRAILERS	4,340.00	4,340.00	0100000108 4400	GF-Unrest-Not Applicable / Non Capitalized Equipment

LOWELL JOINT SD

PURCHASE ORDER DETAIL REPORT
BOARD OF TRUSTEES MEETING 08/08/2022

FROM 06/01/2022 TO 06/30/2022

PO NUMBER	VENDOR	PO TOTAL	ACCOUNT AMOUNT	ACCOUNT NUMBER	PSEUDO / OBJECT DESCRIPTION
R99R0488	SAVVAS LEARNING COMPANY LLC	246,557.30	246,557.30	0163000002 4130	GF-Lottery-Not Applicable / Textbooks
R99R0489	RANCHERS IRRIGATION SUPPLY	281.69	261.55	0100000094 4300	GF-Unrest-Not Applicable / Materials and Supplies
			20.14	0100000095 4300	GF-Unrest-Not Applicable / Materials and Supplies
R99R0490	LOWES	271.30	271.30	0100000094 4300	GF-Unrest-Not Applicable / Materials and Supplies
R99R0491	TRINIDAD, GINA	1,488.38	1,488.38	0105110043 4300	ClsAdmRS-LCAP G1/A8 / Materials and Supplies
R99R0492	BUG FLIP	1,280.00	165.00	0100000117 5570	GF-Unrestricted / Pest Control
			265.00	0100000121 5570	GF-Unrestricted / Pest Control
			165.00	0100000137 5570	GF-Unrestricted / Pest Control
			165.00	0100000138 5570	GF-Unrestricted / Pest Control
			165.00	0100000141 5570	GF-Unrestricted / Pest Control
			355.00	0100000142 5570	GF-Unrestricted / Pest Control
R99R0493	IMPERIAL SPRINKLER SUPPLY	3,714.31	3,714.31	0100000108 4300	GF-Unrest-Not Applicable / Materials and Supplies
R99R0494	DANGELO COMPANY	38.87	38.87	0100000098 4300	GF-Unrest-Not Applicable / Materials and Supplies
R99R0495	UNITED REFRIGERATION INC.	3,421.96	3,421.96	0100000098 4300	GF-Unrest-Not Applicable / Materials and Supplies
R99R0496	UNITED REFRIGERATION INC.	3,408.07	698.62	0100000094 4300	GF-Unrest-Not Applicable / Materials and Supplies
			2,709.45	0100000098 4300	GF-Unrest-Not Applicable / Materials and Supplies
R99R0497	IMPERIAL BAND INSTRUMENTS	23.14	23.14	0105110036 4300	GF-SiteAllocRS-LCAPGL1-Act8 / Materials and Supplies
R99R0498	THE SHERWIN-WILLIAMS CO.	505.99	59.04	0100000092 4300	GF-Unrest-Not Applicable / Materials and Supplies
			118.08	0100000093 4300	GF-Unrest-Not Applicable / Materials and Supplies
			275.92	0100000094 4300	GF-Unrest-Not Applicable / Materials and Supplies
			52.95	0100000098 4300	GF-Unrest-Not Applicable / Materials and Supplies
R99R0499	CASBO	3,500.00	3,500.00	0100000071 5300	GF-Unrest-Not Applicable / Dues and Memberships
R99R0500	GARDENA VALLEY PRINTING	327.00	327.00	0105110044 4300	GF-SiteAlloc RS / Materials and Supplies
R99R0501	IGS SERVICE COMPANY	379.10	163.50	0100000089 5630	GF-Unrest-Not Applicable / Repairs or Maintenance
			215.60	0100000093 5630	GF-Unrest-Not Applicable / Repairs or Maintenance

LOWELL JOINT SD

PURCHASE ORDER DETAIL REPORT

BOARD OF TRUSTEES MEETING 08/08/2022

FROM 06/01/2022 TO 06/30/2022

PO NUMBER	VENDOR	PO		ACCOUNT AMOUNT	ACCOUNT NUMBER	PSEUDO / OBJECT DESCRIPTION
		TOTAL	AMOUNT			
R99R0502	PLUMBING WHOLESALE OUTLET	625.67	29.12	0100000092 4300	GF-Unrest-Not Applicable / Materials and Supplies	
			255.20	0100000093 4300	GF-Unrest-Not Applicable / Materials and Supplies	
			341.35	0100000098 4300	GF-Unrest-Not Applicable / Materials and Supplies	
R99R0503	DANGELO COMPANY	459.25	459.25	0100000093 4300	GF-Unrest-Not Applicable / Materials and Supplies	
R99R0507	SCHOOL FIX	612.96	612.96	0100000092 4300	GF-Unrest-Not Applicable / Materials and Supplies	
R99R0508	PDQ EQUIPMENT RENTAL	382.11	382.11	0100000098 5610	GF-Unrest-Not Applicable / Rentals & Leases	
R99R0509	TOM'S PLUMBING SERVICE	2,425.00	1,850.00	0100000089 5630	GF-Unrest-Not Applicable / Repairs or Maintenance	
			575.00	0100000093 5630	GF-Unrest-Not Applicable / Repairs or Maintenance	
R99R0510	PLUMBING WHOLESALE OUTLET	395.35	29.12	0100000092 4300	GF-Unrest-Not Applicable / Materials and Supplies	
			24.88	0100000093 4300	GF-Unrest-Not Applicable / Materials and Supplies	
			341.35	0100000098 4300	GF-Unrest-Not Applicable / Materials and Supplies	
R99R0513	LA HABRA AREA CHAMBER OF COMME	50.00	50.00	0100000317 4300	GF_UNRESTRICTED_SUPT / Materials and Supplies	
R99R0514	OCDE	75.00	75.00	0100000071 5200	GF-Unrest-Not Applicable / Travel and Conferences	
R99T0067	MONOPRICE INC.	236.03	236.03	0108880039 4300	GF-Technology-Not Applicable / Materials and Supplies	
R99T0069	POWER SCHOOL GROUP LLC	1,387.62	1,387.62	0108880020 5810	GF-Technology-Not Applicable / Licenses/Technology	
S99R0012	CODESP	2,200.00	2,200.00	0100000071 5300	GF-Unrest-Not Applicable / Dues and Memberships	
S99R0013	LAKESHORE LEARNING MATERIALS	374.50	374.50	0156400007 4300	GF-Medi-Cal-Not Applicable / Materials and Supplies	
S99R0016	COASTAL ENTERPRISES	4,644.41	4,644.41	0109110014 4300	GF-DonRS / Materials and Supplies	
S99R0017	REHABMART	1,238.22	1,238.22	0165010001 4300	GF-SpEd-LowIncid-Not Applicable / Materials and Supplies	
S99R0019	SCHOOL SPECIALTY LLC	33,192.23	33,192.23	0126000006 4300	ELOP/Site Admin. / Materials and Supplies	
S99R0020	SOUTHERN CALIFORNIA SCIENCE OL	120.00	120.00	0105110044 4300	GF-SiteAlloc RS / Materials and Supplies	
S99R0021	DEMCO	337.18	337.18	0105110044 4300	GF-SiteAlloc RS / Materials and Supplies	
S99S0002	CDW GOVERNMENT INC.	1,075.58	1,075.58	0108880006 4300	GF-TechAllocMG / Materials and Supplies	
S99T0002	LIBRARY WORLD INC	2,970.00	495.00	0108880055 5810	GF-Technology-Not Applicable / Licenses/Technology	

LOWELL JOINT SD
PURCHASE ORDER DETAIL REPORT
BOARD OF TRUSTEES MEETING 08/08/2022

FROM 06/01/2022 TO 06/30/2022

<u>PO NUMBER</u>	<u>VENDOR</u>	<u>PO TOTAL</u>	<u>ACCOUNT AMOUNT</u>	<u>ACCOUNT NUMBER</u>	<u>PSEUDO / OBJECT DESCRIPTION</u>
S99T0002	*** CONTINUED ***				
S99T0003	INCIDENT IQ LLC	6,914.00	6,914.00	0108880020 5810	GF-Technology-Not Applicable / Licenses/Technology
S99T0004	CDW GOVERNMENT INC.	617.31	617.31	0100890005 4300	GF-TechAllocOlit / Materials and Supplies
S99T0005	DATA IMPRESSIONS	16,844.71	2,741.44	0108880033 5810	GF-Technology-Not Applicable / Licenses/Technology
			2,426.44	0108880034 5810	GF-Technology-Not Applicable / Licenses/Technology
			2,493.99	0108880035 5810	GF-Technology-Not Applicable / Licenses/Technology
			2,903.45	0108880036 5810	GF-Technology-Not Applicable / Licenses/Technology
			2,475.95	0108880037 5810	GF-Technology-Not Applicable / Licenses/Technology
			3,803.44	0108880038 5810	GF-Technology-Not Applicable / Licenses/Technology
S99T0006	APPLE INC.	2,042.52	2,042.52	0156400013 4300	GF-Medi-Cal-Not Applicable / Materials and Supplies
S99T0007	GIGAKOM	98,635.89	12,701.90	0108880014 6400	GF-Technology-Not Applicable / Equipment
			12,701.90	0108880015 6400	GF-Technology-Not Applicable / Equipment
			6,350.95	0108880016 6400	GF-Technology-Not Applicable / Equipment
			12,701.88	0108880017 6400	GF-Technology-Not Applicable / Equipment
			6,350.95	0108880018 6400	GF-Technology-Not Applicable / Equipment
			47,828.31	0108880019 6400	GF-Technology-Not Applicable / Equipment
S99T0008	STS EDUCATION	27,342.01	10,665.59	0108110004 4400	RS/TechAllocation / Non Capitalized Equipment
			16,676.42	0132170002 4400	ELOG-GBEER/RS / Non Capitalized Equipment
		Fund 01 Total:	648,211.51		
		Fund 18 Total:	2,628.46		
		Fund 21 Total:	25,640.00		
		Fund 25 Total:	1,161.00		

LOWELL JOINT SD

PURCHASE ORDER DETAIL REPORT

BOARD OF TRUSTEES MEETING 08/08/2022

FROM 06/01/2022 TO 06/30/2022

<u>PO NUMBER</u>	<u>VENDOR</u>	<u>Fund 40 Total:</u>	<u>PO TOTAL</u>	<u>ACCOUNT AMOUNT</u>	<u>ACCOUNT NUMBER</u>	<u>PSEUDO / OBJECT DESCRIPTION</u>
			10,771.42			
		Total Amount of Purchase Orders:		688,412.39		

LOWELL JOINT SD
Consolidated Check Register
 from 6/1/2022 to 6/30/2022

Check	Payee ID	Payee Name	Reference	Subs	Check Date	Cancel Date	Type	Status	Check Amount
99 00001595	V9900010	ALLIANCE OF SCHOOLS FOR COOPER	050122VSR	OH	06/01/2022		MTW	IS	38,197.81
99 00001596	V9900001	CITY OF LA HABRA WATER DEPARTM	0402050222	OH	06/01/2022		MTW	IS	817.98
99 00001597	V9900005	SOUTHERN CALIFORNIA GAS CO	0415051622MYB	OH	06/01/2022		MTW	IS	27.54
99 00001598	V9900009	VERIZON WIRELESS-LA	9906660385	OH	06/01/2022		MTW	IS	1,763.18
99 00001599	V9900010	WARE DISPOSAL	956813	OH	06/01/2022		MTW	IS	4,063.65
99 00001600	F9900014	BUG FLIP	MAY2022	OH	06/01/2022		MTW	IS	180.00
99 00001601	N9900006	FORM PLASTICS COMPANY	APRMAAY2022	OH	06/01/2022		MTW	IS	3,186.95
99 00001602	F9900045	LADY BUGS ENVIRONMENTAL TERMIT	23243	OH	06/01/2022		MTW	IS	55.00
99 00001603	N9900011	SANDLER BROTHERS	0236164-IN	OH	06/01/2022		MTW	IS	323.70
99 00001604	V9900004	SOUTHERN CALIFORNIA EDISON	0422052222	OH	06/02/2022		MTW	IS	1,843.77
99 00001605	V9900005	SOUTHERN CALIFORNIA GAS CO	0422052322	OH	06/02/2022		MTW	IS	167.80
99 00001606	V9903376	GoTo Communications Inc.	INT7101176669	OH	06/03/2022		MTW	IS	4,463.89
99 00001607	I9900007	LEES, DEBRA	MAY 2022	OH	06/03/2022		MTW	IS	1,400.00
99 00001608	F9900060	THE SHERWIN-WILLIAMS CO.	5450-06	OH	06/03/2022		MTW	IS	624.07
99 00001609	V9903422	Lux Bus America	50537	OH	06/07/2022		MTW	IS	1,000.00
99 00001610	E9900140	MARY JO EVANOFF	MAY-REIMBURS	OH	06/07/2022		MTW	IS	372.28
99 00001611	F9900052	PDQ EQUIPMENT RENTAL	734323	OH	06/07/2022		MTW	IS	330.00
99 00001612	F9900069	WALTERS WHOLESale ELECTRIC	S124071424002	OH	06/07/2022		MTW	IS	2,484.47
99 00001613	N9900004	DRIFTWOOD DAIRY	MAY2022	OH	06/07/2022		MTW	IS	14,030.51
99 00001614	N9900009	P & R PAPER SUPPLY COMPANY	MAY2022	OH	06/07/2022		MTW	IS	6,457.02
99 00001615	N9900013	SOUTHERN CALIFORNIA PIZZA	MAY2022	OH	06/07/2022		MTW	IS	16,546.40
99 00001616	V9900003	ACCO BRANDS USA LLC	4719696715	OH	06/08/2022		MTW	IS	390.29
99 00001617	V9900007	ACTION TROPHY	91632	OH	06/08/2022		MTW	IS	160.21
99 00001618	V9903352	ACTIVE EDUCATION	2201	OH	06/08/2022		MTW	IS	6,656.00
99 00001619	I9900001	ANGIE HUTCHERSON	MAY/JUNE 2022	OH	06/08/2022		MTW	IS	740.04
99 00001620	V9900015	APPLE INC.	AJ02331778	OH	06/08/2022		MTW	IS	174.20
99 00001621	V9900024	BEARCOM	5367775	OH	06/08/2022		MTW	IS	1,229.25
99 00001622	V9900028	BUENA PARK PLAQUE & TROPHY	19249	OH	06/08/2022		MTW	IS	80.81
99 00001623	V9900037	CENGAGE LEARNING	777711274	OH	06/08/2022		MTW	IS	9,568.60
99 00001624	V9903371	CHRIS BECERRA CONSULTING SERVI	MAY 2022 SVCS	OH	06/08/2022		MTW	IS	7,125.00
99 00001625	V9900040	COLLEGE BOARD	EP00133455	OH	06/08/2022		MTW	IS	2,091.00
99 00001626	I9900009	DYLAN ROCKENBACH	MEADOWGRN-21/	OH	06/08/2022		MTW	IS	1,617.00
99 00001627	E9900066	EMILY MONTES	COFA-5/16/22	OH	06/08/2022		MTW	IS	62.14
99 00001628	V9903282	GOVCONNECTON INC.	72824758	OH	06/08/2022		MTW	IS	877.97

LOWELL JOINT SD
Consolidated Check Register
 from 6/1/2022 to 6/30/2022

Check	Payee ID	Payee Name	Reference	Subs	Check Date	Cancel Date	Type	Status	Check Amount
99 00001629	V9903402	HEAR NOW	22202	OH	06/08/2022		MTW	IS	370.00
99 00001630	V9900084	HOUGHTON MIEFLIN HARCOURT	955564418	OH	06/08/2022		MTW	IS	3,931.26
99 00001631	E9900084	JIM COOMBS	MGMTRTREAT,HOH	OH	06/08/2022		MTW	IS	843.42
99 00001632	V9903316	NAPA AUTO PARTS	43022	OH	06/08/2022		MTW	IS	30.83
99 00001633	V9903389	PEAR-PRESIDENT'S EDUCATION AWA	477173	OH	06/08/2022		MTW	IS	181.43
99 00001634	V9900148	QUADIENT FINANCE USA INC.	QUAD ACCT#3175	OH	06/08/2022		MTW	IS	6,619.40
99 00001635	V9900149	QUADIENT LEASING USA INC.	N9419644	OH	06/08/2022		MTW	IS	1,167.58
99 00001636	V9900179	SOUTHWEST SCHOOL SUPPLY	R99X0023SUMME	OH	06/08/2022		MTW	IS	1,940.20
99 00001637	V9900180	SPARKLETTTS	15734879060522	OH	06/08/2022		MTW	IS	162.28
99 00001638	V9903359	WESTONE AUDIO	60755709	OH	06/08/2022		MTW	IS	199.00
99 00001639	B9990010	ERICKSON-HALL CONSTRUCTION	PAY APP# 13	OH	06/08/2022		MTW	IS	339,571.32
99 00001640	B9990011	GHATAODE BANNON ARCHITECTS	4805	OH	06/08/2022		MTW	IS	16,872.80
99 00001641	V9900160	RMA GROUP	79744	OH	06/08/2022		MTW	IS	15,280.75
99 00001642	V9900076	FULLERTON JOINT UNION HS DIST	70RI0120	OH	06/08/2022		MTW	IS	1,161.00
99 00001643	V9900013	AMERICAN EXPRESS	ZOOM-MAY 2022	OH	06/09/2022		MTW	IS	6,317.68
99 00001644	V9900053	DATA IMPRESSIONS	19286-IN	OH	06/09/2022		MTW	IS	18,515.75
99 00001645	V9903271	J TAYLOR EDUCATION INC	0522-17	OH	06/13/2022		MTW	IS	727.65
99 00001646	V9903428	LACOE SFS	SUBSCRIPTION	OH	06/13/2022		MTW	IS	5,316.00
99 00001647	V9900125	MYSTERY SCIENCE	SP-9528	OH	06/13/2022		MTW	IS	5,365.50
99 00001648	U9900001	CITY OF LA HABRA WATER DEPARTM	04020502220L	OH	06/16/2022		MTW	IS	3,506.93
99 00001649	U9900002	FRONTIER	JUNE22	OH	06/16/2022		MTW	IS	65.82
99 00001650	S9990002	GALLAGHER PEDIATRIC THERAP	9849	OH	06/16/2022		MTW	IS	2,649.53
99 00001651	F9900033	GLASBY MAINTENANCE SUPPLY	324277	OH	06/16/2022		MTW	IS	14,038.17
99 00001652	U9900003	MCI A VERIZON COMPANY	409078455	OH	06/16/2022		MTW	IS	4.72
99 00001653	E9900147	MICHELLE BOHEN	061322	OH	06/16/2022		MTW	IS	75.40
99 00001654	V9903405	PARENTPOWERED PBC	1100	OH	06/16/2022		MTW	IS	1,745.00
99 00001655	U9900004	SOUTHERN CALIFORNIA EDISON	0511060922	OH	06/16/2022		MTW	IS	17,465.98
99 00001656	U9900005	SOUTHERN CALIFORNIA GAS CO	0429053122	OH	06/16/2022		MTW	IS	205.56
99 00001657	U9900006	SUBURBAN WATER SYSTEMS	181003219784	OH	06/16/2022		MTW	IS	23,040.59
99 00001658	U9900008	T-MOBILE	0504060322	OH	06/16/2022		MTW	IS	819.36
99 00001659	U9900010	WARE DISPOSAL	995613	OH	06/16/2022		MTW	IS	3,252.47
99 00001660	N9900015	Continental Sales	MAY2022	OH	06/16/2022		MTW	IS	16,722.00
99 00001661	N9900007	GOLD STAR FOODS	MAY2022	OH	06/16/2022		MTW	IS	23,111.71
99 00001662	E9900004	ALAN MAO	MISC-CHROMEBK	OH	06/17/2022		MTW	IS	140.47

LOWELL JOINT SD
Consolidated Check Register
 from 6/1/2022 to 6/30/2022

Check	Payee ID	Payee Name	Reference	Subs	Check Date	Cancel Date	Type	Status	Check Amount
99	00001663	V9903424 ANYWHERE CART	169622	OH	06/17/2022		MTW	IS	367.13
99	00001664	R9900001 BRENT ALLSMAN	JULY2022	OH	06/17/2022		MTW	IS	557.02
99	00001665	R9903247 CAROLYN KANE	JULY2022	OH	06/17/2022		MTW	IS	1,290.56
99	00001666	R9900003 CLAUDIA SCHALCHLIN	JULY2022	OH	06/17/2022		MTW	IS	570.78
99	00001667	E9903244 CRISTIAN BOGDAN	MILEAGE	OH	06/17/2022		MTW	IS	36.97
99	00001668	V9900048 CSM CONSULTING INC.	14952	OH	06/17/2022		MTW	IS	5,675.92
99	00001669	E9900051 DAVID BENNETT	LUNCH 6-30-2022	OH	06/17/2022		MTW	IS	208.34
99	00001670	R9900014 EDDY VEGA	JULY2022	OH	06/17/2022		MTW	IS	557.02
99	00001671	R9900006 EMILY WAKEFIELD	JULY2022	OH	06/17/2022		MTW	IS	570.78
99	00001672	R9900007 GAYLE ROGERS	JULY2022	OH	06/17/2022		MTW	IS	232.94
99	00001673	V9903282 GOVCONNECTON INC.	7286528	OH	06/17/2022		MTW	IS	4,731.82
99	00001674	F9900038 ICS SERVICE COMPANY	34316	OH	06/17/2022		MTW	IS	1,819.10
99	00001675	V9900088 IMPERIAL BAND INSTRUMENTS	M63881	OH	06/17/2022		MTW	IS	693.99
99	00001676	V9900088 IMPERIAL BAND INSTRUMENTS	M67350	OH	06/17/2022		MTW	IS	345.38
99	00001677	V9900088 IMPERIAL BAND INSTRUMENTS	56101	OH	06/17/2022		MTW	IS	165.48
99	00001678	E9900087 JOHN ZAPPULLA	MILEAGE-MAY	OH	06/17/2022		MTW	IS	45.50
99	00001679	R9903248 JULIE ROTH	JULY2022	OH	06/17/2022		MTW	IS	570.78
99	00001680	E9900099 KARI HEINRICH	ESY SUPPLIES	OH	06/17/2022		MTW	IS	47.63
99	00001681	V9900099 LA HABRA AREA CHAMBER OF COMME	REGISTRATION	OH	06/17/2022		MTW	IS	150.00
99	00001682	R9900013 MARGARET DUMADAG	JULY2022	OH	06/17/2022		MTW	IS	557.02
99	00001683	V9900123 MONOPRICE INC.	22665823	OH	06/17/2022		MTW	IS	247.04
99	00001684	R9900009 NANCY WHITE	JULY2022	OH	06/17/2022		MTW	IS	1,290.56
99	00001685	V9900134 OCDE	94RI4998	OH	06/17/2022		MTW	IS	4,200.00
99	00001686	R9900010 PENNY MAYERCHECK	JULY2022	OH	06/17/2022		MTW	IS	1,290.56
99	00001687	V9900142 POWER SCHOOL GROUP LLC	307632	OH	06/17/2022		MTW	IS	1,387.62
99	00001688	R9900011 RONALD RANDOLPH	JULY2022	OH	06/17/2022		MTW	IS	614.88
99	00001689	R9900012 SHELLEY MARKER	JULY2022	OH	06/17/2022		MTW	IS	570.78
99	00001690	V9900200 UNUM LIFE INSURANCE COMPANY	BL0160188JUN22	OH	06/17/2022		MTW	IS	542.73
99	00001691	U9900010 WARE DISPOSAL	995603	OH	06/17/2022		MTW	IS	854.45
99	00001692	R9900002 BRUCE PATULLO	JULY2022	OH	06/17/2022		MTW	IS	557.02
99	00001693	V9903306 GAMETIME	0178270 0178274	OH	06/17/2022		MTW	IS	127,811.72
99	00001694	B9990013 HAUFFE COMPANY	436	OH	06/17/2022		MTW	IS	14,112.00
99	00001695	V9903394 AMSCOPE	474250	OH	06/20/2022		MTW	IS	338.73
99	00001696	F9900014 BUG FLIP	478226	OH	06/20/2022		MTW	IS	1,280.00

LOWELL JOINT SD
Consolidated Check Register
 From 6/1/2022 to 6/30/2022

Check	Payee ID	Payee Name	Reference	Subs	Check Date	Cancel Date	Type	Status	Check Amount
99 00001697	V9903431	CALPERS	1000000016838395	OH	06/20/2022		MTW	IS	440,000.00
99 00001698	V9903362	DELL MARKETING L.P.	10592040642	OH	06/20/2022		MTW	IS	3,805.27
99 00001699	V9900056	DELTA DENTAL OF CALIFORNIA	BE004987453	OH	06/20/2022		MTW	IS	1,951.21
99 00001700	F9900039	IMPERIAL SPRINKLER SUPPLY	5092615	OH	06/20/2022		MTW	IS	3,714.32
99 00001701	V9900094	J.W.PEPPER & SON INC.	364231739	OH	06/20/2022		MTW	IS	282.14
99 00001702	V9903291	JEANETTE TREVINO	REIMBURSEMENT	OH	06/20/2022		MTW	IS	26.95
99 00001703	F9900047	LOWES	961011	OH	06/20/2022		MTW	IS	271.30
99 00001704	V9903429	RANCHERS IRRIGATION SUPPLY	5158	OH	06/20/2022		MTW	IS	281.69
99 00001705	V9900154	READYREFRESH BY NESTLE	02F0032621385	OH	06/20/2022		MTW	IS	73.85
99 00001706	V9900169	SCHOOL DATEBOOKS	S22-0226708	OH	06/20/2022		MTW	IS	803.68
99 00001707	V9900172	SCHOOL SERVICES OF CALIFORNIA	0133680-IN	OH	06/20/2022		MTW	IS	340.00
99 00001708	V9903299	SCHOOL SPECIALTY LLC	208129990810	OH	06/20/2022		MTW	IS	1,592.52
99 00001709	V9900179	SOUTHWEST SCHOOL SUPPLY	STHWST	OH	06/20/2022		MTW	IS	8,117.36
99 00001710	V9903425	SPORTS JACKETS UNLIMITED	4557	OH	06/20/2022		MTW	IS	460.85
99 00001711	V9900183	STUDIES WEEKLY	437629	OH	06/20/2022		MTW	IS	13,056.07
99 00001712	I9900011	TRINIDAD, GINA	RS-86137-017	OH	06/20/2022		MTW	IS	2,095.83
99 00001713	V9900204	VIG SOLUTIONS	11048	OH	06/20/2022		MTW	IS	325.24
99 00001714	V9903396	WARD'S MEDIA TECH	154391	OH	06/20/2022		MTW	IS	30,200.78
99 00001715	V9903430	DANGELO COMPANY	S1466487.001	OH	06/24/2022		MTW	IS	38.87

Issued: 1,342,256.27
 99 Bank Total: 1,342,256.27

Grand Total: 1,342,256.27

Lowell Joint School District

2021-22 Estimated Actuals Budget Adjustment Summary

Fund 01 - General Fund - Unrestricted/Restricted

Description	Object	SI21-22	EA21-22	Change
Revenues	8000	\$38,075,453	\$38,877,856	\$802,403
Certificated Salaries	1000	\$16,405,949	\$16,678,209	\$272,260
Classified Salaries	2000	\$5,537,734	\$5,470,263	-\$67,471
Employee Benefits	3000	\$9,611,346	\$9,768,375	\$157,029
Books and Supplies	4000	\$3,915,824	\$3,912,047	-\$3,777
Services & Other Operating Exp.	5000	\$3,490,495	\$2,954,136	-\$536,359
Capital Outlay	6000	\$78,390	\$78,389	-\$1
	7100-7299			
Other Outgo	7400-7499	\$387,200	\$363,537	-\$23,663
Other Outgo	7300-7399	-\$50,000	-\$45,800	\$4,200
Total Expenditures				-\$197,782
Fund Balance Adjustment Total				\$1,000,185

Lowell Joint School District

2021-22 Estimated Actuals Budget Adjustment Summary

Fund 13 - Cafeteria Fund

Description	Object	SI21-22	EA21-22	Change
Revenues	8000	\$898,516	\$1,987,019	\$1,088,503
Certificated Salaries	1000	-	-	
Classified Salaries	2000	\$552,123	\$540,772	-\$11,351
Employee Benefits	3000	\$189,786	\$182,661	-\$7,125
Books and Supplies	4000	\$501,653	\$651,548	\$149,895
Services & Other Operating Exp.	5000	\$30,286	\$18,228	-\$12,058
Capital Outlay	6000	\$100,000	\$0	-\$100,000
Other Outgo	7000	\$50,000	\$45,800	-\$4,200
Total Expenditures				\$15,161
Fund Balance Adjustment Total				\$1,073,342

Lowell Joint School District

2021-22 Estimated Actuals Budget Adjustment Summary

Fund 14 - Deferred Maintenance Fund

Description	Object	SI21-22	EA21-22	Change
Revenues	8000	\$55,632	\$91,513	\$35,881
Certificated Salaries	1000	-	-	
Classified Salaries	2000	\$58,944	\$58,944	\$0
Employee Benefits	3000	\$49,398	\$42,398	-\$7,000
Books and Supplies	4000	\$5,000	\$5,000	\$0
Services & Other Operating Exp.	5000	\$446,018	\$500,000	\$53,982
Capital Outlay	6000	\$224,534	\$224,534	\$0
Other Outgo	7000	\$0	\$0	\$0
Total Expenditures				\$46,982
Fund Balance Adjustment Total				-\$11,101

Lowell Joint School District

2021-22 Estimated Actuals Budget Adjustment Summary

Fund 21 - Building Fund

Description	Object	SI21-22	EA21-22	Change
Revenues	8000	\$120,000	\$161,338	\$41,338
Certificated Salaries	1000	-	-	
Classified Salaries	2000	\$82,516	\$82,516	\$0
Employee Benefits	3000	\$36,994	\$36,994	\$0
Books and Supplies	4000	\$0	\$0	\$0
Services & Other Operating Exp.	5000	\$516,466	\$511,974	-\$4,492
Capital Outlay	6000	\$12,356,977	\$11,600,021	-\$756,956
Other Outgo	7000	\$0	\$0	\$0
Total Expenditures				-\$761,448
Fund Balance Adjustment Total				\$802,786

Lowell Joint School District

2021-22 Estimated Actuals Budget Adjustment Summary

Fund 25 - Capital Facilities Fund

Description	Object	SI21-22	EA21-22	Change
Revenues	8000	\$25,400	\$36,709	\$11,309
Certificated Salaries	1000	-	-	
Classified Salaries	2000	\$0	\$0	\$0
Employee Benefits	3000	\$0	\$0	\$0
Books and Supplies	4000	\$0	\$0	\$0
Services & Other Operating Exp.	5000	\$330	\$1,000	\$670
Capital Outlay	6000	\$1,000,000	\$1,000,000	\$0
Other Outgo	7000	\$0	\$0	\$0
Total Expenditures				\$670
Fund Balance Adjustment Total				\$10,639

Lowell Joint School District

2021-22 Estimated Actuals Budget Adjustment Summary

Fund 40 - Capital Outlay Projects

Description	Object	SI21-22	EA21-22	Change
Revenues	8000	\$4,049,552	\$4,191,356	\$141,804
Certificated Salaries	1000	-	-	
Classified Salaries	2000	-	-	
Employee Benefits	3000	-	-	
Books and Supplies	4000	\$5,366	\$19,400	\$14,034
Services & Other Operating Exp.	5000	\$225,184	\$164,244	-\$60,940
Capital Outlay	6000	\$129,000	\$157,582	\$28,582
Other Outgo	7000	\$0	\$0	\$0
Total Expenditures				-\$18,324
			Fund Balance Adjustment Total	\$160,128

LOWELL JOINT SCHOOL DISTRICT
EMPLOYER-EMPLOYEE RELATIONS PERSONNEL REPORT 2022/2023 #1

August 8, 2022

I. CERTIFICATED EMPLOYEES

A. RESIGNATION				
NAME	<u>EFFECTIVE</u> DATE	SITE	COMMENTS	
Garduno, Adam	07/07/2022	RS	Resignation. Rancho Starbuck Teacher.	
B. <u>2022/2023 CONTRACTS</u>				
NAME	<u>EFFECTIVE</u> DATE	<u>CLASS/COL/</u> <u>STEP</u>	SITE	COMMENTS
Woo, Chuck	08/15/2022	C4/S6	RS	Temporary Contract. Rancho Starbuck Math Teacher Teacher

* It is further recommended that these individuals be approved for substitute teaching at the rate of \$200.00 per day and/or \$35.00 an hour rate (not to exceed six hours) as applicable and to include: Professional Development, Saturday School, Site Support Duties and Intervention

**It is further recommended that the individuals listed in Certificated Salaries for 2022-2023 is approved to instruct in the Intervention Programs. The rate of pay is \$35.00/hour and will be paid from Title I or LCFF Supplemental Grant Funds.

**It is further recommended that individuals listed in Certificated Salaries for 2022-2023 serve as home school teachers, if needed, for the 2022-2023 school year at a rate of \$35.00/hour, not to exceed five hours per week, per student. Mileage will be paid at the IRS Standard Mileage Rate for the 2022-2023 school year.

II. CLASSIFIED EMPLOYEES August 8, 2022

<u>NAME/</u> <u>EMPLOYEE ID#</u>	<u>EFFECTIVE</u> <u>DATE</u>	<u>END</u> <u>DATE</u>	<u>RANGE/</u> <u>STEP</u>	<u>SITE</u>	<u>COMMENTS</u>
Alarid, Emily	07/25/2022	08/05/2022		DO	Bootcamp: CW 11:00-1:00
Alcantara, Marissa	07/18/2022			MG	Resignation: Noon Duty Aide
Allsman, Katelyn	07/25/2022	08/05/2022	R14/S1	DO	Bootcamp: Noon Duty Aide 11:45-1:15
Anderson, Adriana	07/25/2022	08/05/2022		DO	Bootcamp: CW 10:00-12:00
Ayers, Becca	08/15/2022	12/23/2022		OL	Unpaid Leave of Absence - IA
Barber, Stephanie	07/17/2022			DO	Resignation: Admin Asst. Bus Serv.
Barber, Stephanie	07/18/2022			DO	Substitute: Admin Asst. Bus Serv.
Bautista, Selah	07/18/2022		R21/S7	DO	New Hire: Secretary of Guidance SPED
Castro, Claudia	08/10/2022		R16/S1	JO	New Hire: Clerk Typist
Cramer, Samantha	08/08/2022		R20/S1	TBD	New Hire: Classified Preschool Teacher
Duran, Julie	07/13/2022		R21/S1	DO	Substitute: Admin Asst. Bus Serv.
Edwards, Sarah	07/01/2022	06/30/2023	R28/S3	RS	Maintenance Lockers
Estrada, Liz	07/25/2022	08/05/2022	R14/S6	DO	Bootcamp: IA 7:30-12:30
Felix, Lisa	08/15/2022		R20/S4	MA	New Hire-Librarian/Media Tech
Garcia, Gabriella	03/15/2022	03/25/2022			Resignation: IA, Sped, ABA Substitute
Hernandez, Darlene	07/01/2022	08/14/2022	R14/S1	DO	IA/Substitute/Summer
Hernandez, Darlene	08/15/2022		R14/S1	DO	Substitute Instructional Aide
Hutcheson, Janel	06/06/2022	06/30/2022	R28/S1	RS	Maintenance Lockers
Lepe, Caroline	07/25/2022	08/05/2022	R14/S4	DO	Bootcamp: IA 7:30-12:30
Lopez, Donna	07/25/2022	08/05/2022	R15/S8	DO	Bootcamp: IA Sub 7:30-12:30
Lord, Dixie	06/10/2022	06/30/2022	R28/S3	RS	Maintenance Lockers
Miza, Kelly	08/16/2022	06/02/2023		EP	IA/RSP: Increase hours to 5.50

Muravez, Alicia	07/25/2022	08/05/2022		DO	Bootcamp: SCW 9:30-12:30
Nunez, Marie	07/25/2022	08/08/2022	R1/S1	DO	Bootcamp: Noon Duty Aide 11:45-1:15
Padilla, Myra	06/13/2022		R23/S7	DO	Step Increase-Fiscal Clerk
Perez, Stephanie	08/08/2022		R20/S1	TBD	New Hire-Classified Preschool Teacher
Pullen, Darleene	08/16/2022	06/02/2023		MG	IA/RSP: Increase hours to 5.50
Palmer, Mary	08/16/2023	06/02/2023		RS	IA/RSP: Increase hours to 5.50
Reyatt, Manjit	08/17/2022	11/01/2022	NDA/01/01	MG	Unpaid Leave of Absence-Noon Duty Aide. Correction of EER #12 21-22
Rickenbacker, Kim	08/03/2022		R23/S4	EP	New Hire-Office Manager Correction of Date
Rodia, Sue	08/16/2022	06/02/2023		OL	IA/RSP: Increase hours to 5.50
Roe, Amy	07/11/2022		R	OL	Resignation: Instructional Assistant
Sanchez, Kris	07/25/2022	08/05/2022		DO	Bootcamp: SCW 9:30-12:30
Serrano, Tena	06/09/2022	06/30/2022	R18/S8	RS	Maintenance Lockers
Valdez, Faith	08/16/2022	06/02/2023		MA	IA/RSP: Increase hours to 5.50
Watson, Jill	8/16/2022	06/02/2023		JO	IA/RSP: Increase hours to 5.50
Winik, Rebecca	08/16/2022	06/02/2023		RS	IA/RSP: Increase hours to 5.50
Ybarra, Mariana	07/25/2022	08/05/2022	R14/S8	DO	Bootcamp: IA 7:30-12:30

CLASSIFIED JOB DESCRIPTIONS

Addition:

- Child Development (1)
- Child Development (2)
- Child Development (3)
- Health Technician
- Licensed Vocational Nurse



LOWELL JOINT SCHOOL DISTRICT CHILD DEVELOPMENT ASSISTANT I

Classified Salary Schedule
Range 14

JOB SUMMARY:

Under supervision, assist in the supervision, management, safety and well-being of students during a child development program, which may include a district preschool program and/or a district school age before and after school program.

DISTINGUISHING CHARACTERISTICS:

This classification is distinguished from other Instructional Assistant classifications in that the primary responsibility is working with students in the Child Development department.

ESSENTIAL FUNCTIONS:

The duties listed below are intended only as illustrations of the various types of work that may be performed. The omission of specific statements of duties does not exclude them from the position if the work is similar, related, or a logical assignment to the class.

- Assist teachers in a learning environment designed to develop the physical, cognitive, emotional, creative and social skills of child development students.
- Assist in the preparation of a variety of instructional materials and learning aids designed for learning of child development students.
- Supervise small groups or individual students under the directions of the assigned supervisor; monitor students on the playground.
- Demonstrate standards of behavior and utilize a positive approach while working with children.
- Assist with snacks and other meals as appropriate; set up plates and meals; clean serving area after meals; assist students with cleanliness, brushing teeth and toileting as needed.
- Maintain and assure a clean, safe, attractive and positive learning environment; perform light housekeeping duties, including cleaning the classroom after students leave and preparing for the next day.
- May set up and operate simple audio-visual equipment, assisting students to learn with the use of computers and other teaching aids.
- Assist in administering routine first aid to students as needed; assist in toileting, administering medication and medical procedures in accordance with specific medical instructions as assigned
- Participate in meetings and in-service training programs as assigned.
- Assist with classroom preparation and materials, maintaining a clean and safe learning environment.
- Routinely squat, crouch, sit on small chairs, and hard surfaces with students.
- Perform other related duties as assigned.

QUALIFICATION GUIDELINES:

Knowledge of:

- Basic concepts used in Early Childhood Education/Child Development
- Program policies, practices and procedures.
- Safe classroom and playground practices.
- Health and safety precautions and procedures
- Basic first aid procedures and health and safety regulations.
- Interpersonal relations skills using tact, patience and courtesy.

Ability to:

- Appropriately manage student behavior and guide students toward acceptable social behavior.
- Implement learning activities for children while maintaining a healthy and safe environment.
- Monitor and assist students.
- Squat, crouch or sit on small chairs low to the ground or hard floors.
- Demonstrate understanding, patient and receptive attitude toward students and staff.
- Work confidentially with discretion and independently with little supervision.
- Communicate clearly and concisely, both orally and in writing.
- Establish and maintain cooperative and effective working relationships with others.
- Perform routine clerical duties.
- Lift and move items weighing up to 50 pounds.

Education/Training/Licenses/Experience:

Graduation from high school or its equivalent and must successfully pass the District's local assessment test.

PHYSICAL STANDARDS AND WORKING CONDITIONS:

The physical and mental demands and work environment described here are representative of those that must be met by employees to successfully perform the essential functions of this class. Reasonable accommodations may be made to enable individuals with disabilities to perform the essential functions. These physical demands are generic in nature and tasks may vary dependent on specific trade and or specialized work assignment.

Physical Demands:

Physical demands of this position include sitting and standing for extended periods. The employee may frequently move or lift children weighing up to 50 pounds unassisted. Occasional bending at the waist is required, as is kneeling, crouching, squatting, pushing and pulling. Employees may reach overhead as well as above the shoulders and horizontally.

Mental Demands:

Employee must be able to comprehend and follow written and oral instructions; interpret policies and procedures; and interact cooperatively with District staff, parents, and the public.

Work Environment:

While performing the duties of this job, the employee works in several environments including classroom, indoor and outdoor environments and on or near student playground equipment.

The information contained in the physical standards description is for compliance with ADA and is not an exhaustive list of duties performed. Individuals who hold this position may perform additional duties and additional duties may be assigned.

WORK PERIOD:

10 months per year, 5 days per week, up to 3.75 hours/day



LOWELL JOINT SCHOOL DISTRICT CHILD DEVELOPMENT ASSISTANT 2

Classified Salary Schedule
Range 15

JOB SUMMARY:

Under supervision, assist in the supervision, management, safety and well-being of students during a child development program, which may include a district preschool program and/or a district school age before and after school program.

DISTINGUISHING CHARACTERISTICS:

This classification is distinguished from other Instructional Assistant classifications in that the primary responsibility is working with students in the Child Development department.

ESSENTIAL FUNCTIONS:

The duties listed below are intended only as illustrations of the various types of work that may be performed. The omission of specific statements of duties does not exclude them from the position if the work is similar, related, or a logical assignment to the class.

- Assist teachers in a learning environment designed to develop the physical, cognitive, emotional, creative and social skills of child development students.
- Assist in the preparation of a variety of instructional materials and learning aids designed for learning of child development students.
- Supervise small groups or individual students under the directions of the assigned supervisor; monitor students on the playground.
- Demonstrate standards of behavior and utilize a positive approach while working with children.
- Assist with snacks and other meals as appropriate; set up plates and meals; clean serving area after meals; assist students with cleanliness, brushing teeth and toileting as needed.
- Maintain and assure a clean, safe, attractive and positive learning environment; perform light housekeeping duties, including cleaning the classroom after students leave and preparing for the next day.
- May set up and operate simple audio-visual equipment, assisting students to learn with computers and other teaching aids.
- Assist in administering routine first aid to students as needed; assist in toileting, administering medication and medical procedures in accordance with specific medical instructions as assigned
- Participate in meetings and in-service training programs as assigned.
- Assist with classroom preparation and materials, maintaining a clean and safe learning environment.
- Routinely squat, crouch, sit on small chairs, and hard surfaces with students.
- Perform other related duties as assigned.

QUALIFICATION GUIDELINES:

Knowledge of:

- Basic concepts used in Early Childhood Education/Child Development
- Program policies, practices and procedures.
- Safe classroom and playground practices.
- Health and safety precautions and procedures
- Basic first aid procedures and health and safety regulations.
- Interpersonal relations skills using tact, patience and courtesy.

Ability to:

- Appropriately manage student behavior and guide students toward acceptable social behavior.
- Implement learning activities for children while maintaining a healthy and safe environment.
- Monitor and assist students.
- Squat, crouch or sit on small chairs low to the ground or hard floors.
- Demonstrate understanding, patient and receptive attitude toward students and staff.
- Work confidentially with discretion and independently with little supervision.
- Communicate clearly and concisely, both orally and in writing.
- Establish and maintain cooperative and effective working relationships with others.
- Perform routine clerical duties.
- Lift and move items weighing up to 50 pounds.

Education/Training/Licenses/Experience:

1. Graduation from high school or its equivalent. Must also successfully pass the District's local assessment test.
2. 12 college level units in Early Childhood Education, Child Development, or related field.

PHYSICAL STANDARDS AND WORKING CONDITIONS:

The physical and mental demands and work environment described here are representative of those that must be met by employees to successfully perform the essential functions of this class. Reasonable accommodations may be made to enable individuals with disabilities to perform the essential functions. These physical demands are generic in nature and tasks may vary dependent on specific trade and or specialized work assignment.

Physical Demands:

Physical demands of this position include sitting and standing for extended periods. The employee may frequently move or lift children weighing up to 50 pounds unassisted. Occasional bending at the waist is required, as is kneeling, crouching, squatting, pushing and pulling. Employees may reach overhead as well as above the shoulders and horizontally.

Mental Demands:

Employee must be able to comprehend and follow written and oral instructions; interpret policies and procedures; and interact cooperatively with District staff, parents, and the public.

Work Environment:

While performing the duties of this job, the employee works in several environments including classroom, indoor and outdoor environments and on or near student playground equipment.

The information contained in the physical standards description is for compliance with ADA and is not an exhaustive list of duties performed. Individuals who hold this position may perform additional duties and additional duties may be assigned.

WORK PERIOD:

10 months per year, 5 days per week, up to 3.75 hours/day



LOWELL JOINT SCHOOL DISTRICT CHILD DEVELOPMENT ASSISTANT 3

Classified Salary Schedule
Range 17

JOB SUMMARY:

Under supervision, assists in the supervision, management, safety and well-being of students during a child development program, which may include a district preschool program and/or a district school age before and after school program.

DISTINGUISHING CHARACTERISTICS:

This classification is distinguished from other Instructional Assistant classifications in that the primary responsibility is working with students in the Child Development department.

ESSENTIAL FUNCTIONS:

The duties listed below are intended only as illustrations of the various types of work that may be performed. The omission of specific statements of duties does not exclude them from the position if the work is similar, related, or a logical assignment to the class.

- Assist teachers in a learning environment designed to develop the physical, cognitive, emotional, creative and social skills of child development students.
- Assist in the preparation of a variety of instructional materials and learning aids designed for learning of child development students.
- Supervise small groups or individual students under the directions of the assigned supervisor; monitor students on the playground.
- Demonstrate standards of behavior and utilize a positive approach while working with children.
- Assist with snacks and other meals as appropriate; set up plates and meals; clean serving area after meals; assist students with cleanliness, brushing teeth and toileting as needed.
- Maintain and assure a clean, safe, attractive and positive learning environment; perform light housekeeping duties, including cleaning the classroom after students leave and preparing for the next day.
- May set up and operate simple audio-visual equipment, assisting students to learn with computers and other teaching aids.
- Assist in administering routine first aid to students as needed; assist in toileting, administering medication and medical procedures in accordance with specific medical instructions as assigned
- Participate in meetings and in-service training programs as assigned.
- Assist with classroom preparation and materials, maintaining a clean and safe learning environment.
- Routinely squat, crouch, sit on small chairs, and hard surfaces with students.
- Perform other related duties as assigned.

QUALIFICATION GUIDELINES:

Knowledge of:

- Basic concepts used in Early Childhood Education/Child Development
- Program policies, practices and procedures.
- Safe classroom and playground practices.
- Health and safety precautions and procedures
- Basic first aid procedures and health and safety regulations.
- Interpersonal relations skills using tact, patience and courtesy.

Ability to:

- Appropriately manage student behavior and guide students toward acceptable social behavior.
- Implement learning activities for children while maintaining a healthy and safe environment.
- Monitor and assist students.
- Squat, crouch or sit on small chairs low to the ground or hard floors.
- Demonstrate understanding, patient and receptive attitude toward students and staff.
- Work confidentially with discretion and independently with little supervision.
- Communicate clearly and concisely, both orally and in writing.
- Establish and maintain cooperative and effective working relationships with others.
- Perform routine clerical duties.
- Lift and move items weighing up to 50 pounds.

Education/Training/Licenses/Experience:

1. Graduation from high school or its equivalent. Must successfully pass the District's local assessment test.
2. 24 college level units, 12 of which need to be in Early Childhood Education, Child Development, or related field.
3. At least one year of experience working with children in a child development program or equivalent.

PHYSICAL STANDARDS AND WORKING CONDITIONS:

The physical and mental demands and work environment described here are representative of those that must be met by employees to successfully perform the essential functions of this class. Reasonable accommodations may be made to enable individuals with disabilities to perform the essential functions. These physical demands are generic in nature and tasks may vary dependent on specific trade and or specialized work assignment.

Physical Demands:

Physical demands of this position include sitting and standing for extended periods. The employee may frequently move or lift children weighing up to 50 pounds unassisted. Occasional bending at the waist is required, as is kneeling, crouching, squatting, pushing and pulling. Employees may reach overhead as well as above the shoulders and horizontally.

Mental Demands:

Employee must be able to comprehend and follow written and oral instructions; interpret policies and procedures; and interact cooperatively with District staff, parents, and the public.

Work Environment:

While performing the duties of this job, the employee works in several environments including classroom, indoor and outdoor environments and on or near student playground equipment.

The information contained in the physical standards description is for compliance with ADA and is not an exhaustive list of duties performed. Individuals who hold this position may perform additional duties and additional duties may be assigned.

WORK PERIOD:

10 months per year, 5 days per week, up to 3.75 hours/day

HEALTH TECHNICIAN



Classified Salary Schedule
Range 16

JOB SUMMARY:

Under direct supervision, performs a variety of clerical work of average difficulty including word processing, data entry, and other general office duties and performs related duties as required.

ESSENTIAL FUNCTIONS:

The duties listed below are intended only as illustrations of the various types of work that may be performed. The omission of specific statements of duties does not exclude them from the position if the work is similar, related, or a logical assignment to the class.

- Administers first aid and contacts appropriate emergency assistance and routine first aid procedures; attends to sick and injured students as necessary and administers medication according to physician's instructions and in accordance with the Education Code.
- May perform specialized physical health care services including, but not limited to, insulin and/or glucagon administration, catheterization, gastrostomy feeding, suctioning, ostomy care, postural drainage, and tracheotomy care, in accordance to training and supervision by the district school nurse.
- Assists the District's credentialed school nurse with routine health testing programs including, vision, dental, health, and hearing screening.
- May administer various forms of medication upon prior parental/physician authorization.
- Performs general medical/clerical work, records various types of data, and maintains confidential records.
- Maintains school health office, including keeping records of first aid supplies and ordering as needed.
- May assist parents in the completion of health records and forms and explains basic aspects of various health programs and required immunizations; follows up on student health records to assure compliance with State laws.
- May participate in workshops and in-services as required. Checks for lice on an as needed basis. Performs other related duties as assigned.
- Performs a variety of clerical tasks, including word-processing, data entry, proofreading, filing, and the recording of information. Checks and reviews a variety of data for completeness and conformance with established regulations and procedures.
- Answers the telephone and responds accordingly with routine information and data.
- Makes appointments and receives visitors by answering routine inquiries, providing them with information and data, and by directing them to the appropriate office.
- Provides information regarding school matters over the counter and by telephone.
- Compiles information and prepares reports and summaries.
- Performs other related duties as assigned.

QUALIFICATION GUIDELINES:

Knowledge of:

- Diabetes Management
- First Aid techniques and practices
- General needs and behavior of children, including basic elements of child growth and development
- Basic aspects of various health programs and equipment; health and safety regulations
- Operation of standard office equipment, including a computer, typewriter, and copy machine
- Proper English usage and communication skills
- Telephone etiquette
- Appropriate safety precautions and procedures.
- Modern office practices and procedures, including filing systems, telephone techniques and etiquette.
- Record keeping and methods of collecting and organizing data and information.
- Correct English usage, grammar, spelling, and proofreading.
- Oral and written communication skills and interpersonal skills using tact, patience and courtesy.
- General knowledge of modern office equipment and computer programs.

Ability to:

- Administer First Aid and CPR
- Understand and follow oral and written instructions
- Remain calm in emergency situations
- Analyze situations accurately
- Make good judgments and work independently with minimal supervision, meeting schedules and time lines.
- Maintain confidentiality
- Learn specialized physical health care services
- Deal effectively with students, staff and parents
- Efficiently prioritize and organize job responsibilities.
- Operate standard office machines including a computer using presentation, word processing, spreadsheet, and database software applications.
- Understand, interpret, explain, and apply school and District policies and procedures.
- Communicate clearly and effectively, both orally and in writing, with administrators, students, staff, parents and the public.
- Establish and maintain cooperative and effective working relationships with others.

Education/Training/Experience:

Some previous experience working with children in an educational, health care or child care setting, or any combination of training and experience that could likely provide the desired knowledge and abilities; high school diploma or its equivalent; some experience in a medical setting and one year clerical experience preferred; First Aid and CPR Certification desirable

Licenses/Certificates/Special Requirements:

A valid California Driver's License and the ability to maintain insurability under the District's Vehicle Insurance Policy.

PHYSICAL STANDARDS AND WORKING CONDITIONS:

The physical and mental demands and work environment described here are representative of those that must be met by employees to successfully perform the essential functions of this class. Reasonable accommodations may be made to enable individuals with disabilities to perform the essential functions. These physical demands are generic in nature and tasks may vary dependent on specific trade and or specialized work assignment.

Physical Demands:

Ability to lift up to 50 pounds without assistance, and be physically able to assist students who may have physical disabilities. Dexterity of hands and fingers to work with students. Standing or sitting for an extended period of time. Reaching overhead, above the shoulders and horizontally to work with and assist students. Some walking and standing on various surfaces as well as bending and reaching at the waist, below and above shoulder level, kneeling, and crouching. Repetitive use of fingers and hands to operate a keyboard and other office equipment is necessary; hearing and speaking ability sufficient to provide information via phone, intercom and personal contact is also needed. Specific vision abilities including close vision, depth perception and the ability to focus are required in order to read materials and assist students.

Work Environment:

While performing the duties of this job the employee works in several environments including a school office, classroom, indoor and outdoor environments and on or near student playground equipment as needed. The employees' primary responsibility is working with students in the health office. Employees in this position may have a higher level of exposure to infection and physical injury from students. This position may also involve the following: frequent interruption and direct contact with staff and the public; a high volume of responsibilities that may require working without direct and/or constant supervision; and working in a school office environment where the noise level is usually moderate.

The information contained in the physical standards description is for compliance with ADA and is not an exhaustive list of duties performed. Individuals who hold this position may perform additional duties and additional duties may be assigned.

WORK PERIOD:

10 months per year, 5 days per week, 3.75 hours per day

Health Technician-sb

Board Approved: To be approved August 8, 2022

Revised: July 2022

Reviewed: June 2022



LOWELL JOINT SCHOOL DISTRICT

LICENSED VOCATIONAL NURSE

Classified Salary Schedule
Range 23

JOB SUMMARY:

Under the general oversight of the Director of Special Education, and the supervision of the credentialed school nurse and consistent with licensing requirements, applicable laws and regulations, provides a variety of health services to students; maintains health records, referrals and reports; administers routine first-aid, assists in screening ill, injured, and medically fragile students in accordance with State law and District regulations; and with health testing programs and other health related services as required.

ESSENTIAL FUNCTIONS:

The duties listed below are intended only as illustrations of the various types of work that may be performed. The omission of specific statements of duties does not exclude them from the position if the work is similar, related, or a logical assignment to the classification.

- Performs and administers routine first aid procedures; attends to sick and injured students.
- Provides support for regular check-in and preventive support services for the needs of foster youth, adopted, homeless or McKinney Vento students.
- Performs specialized physical health care services including, but not limited to, blood glucose testing, catheterization, gastrostomy feeding, suctioning, ostomy care, postural drainage, and tracheotomy care, under the supervision of the credentialed school nurse.
- Maintains a variety of health related records both manual and electronic (e.g. confidential student health records, emergency medical records, accident reports, health & disability records, medication records, etc.) for the purpose of providing information required by regulatory requirements.
- Assists the District's credentialed school nurse with routine health testing programs including, vision, dental, health, and hearing screening, for the purpose of coordinating screenings, contacting parents and recording results of screenings
- Administer various forms of medication upon prior parental/physician authorization.
- Performs general medical/clerical work, records various types of data, maintains confidential records.
- Assists parents in the completion of health records and forms and explains basic aspects of various health programs and required immunizations; follows up on student health records to assure compliance with State laws.
- Assists students when necessary with daily living self-care skills, including diapering, toileting, feeding and other self-help skills.
- Contacts parents regarding student's health or emotional needs.
- May participate in workshops and in-services as required.
- Attends specialized trainings to help support foster youth, adopted, homeless or McKinney Vento students
- Performs other related duties as assigned.

QUALIFICATION GUIDELINES:

Knowledge of:

- First Aid practices and health and safety regulations
- Appropriate safety precautions and procedures
- Needs of medically fragile students
- Correct medical procedures for specialized health needs
- General needs and behavior of children, including basic elements of child growth and development
- Basic aspects of various health programs and equipment

- General knowledge of Modern office equipment and computer software programs such as word processing and database entry
- Modern office practices and procedures, including filing systems, telephone techniques and etiquette
- Record keeping and methods of collecting and organizing data and information
- Correct English usage, grammar, spelling and proofreading
- Oral and written communication skills

Ability to:

- Administer First Aid and CPR to ill or injured students
- Organize and perform duties with a minimum of supervision
- Remain calm in emergency situations
- Analyze situations accurately
- Make good judgments without immediate supervision
- Maintain confidentiality
- Learn specialized physical health care services
- Efficiently prioritize and organize job responsibilities.
- Communicate clearly and effectively, both orally and in writing, with students, staff, parents and the public
- Use interpersonal techniques with tact, patience and courtesy
- Maintain reliable, consistent, punctual regular attendance

Education/Training/Experience:

High school diploma or its equivalent. Some previous nursing experience in a hospital, clinic, or school environment, preferably including experience in dealing with preschool and school age children. Must have valid California Licensed Vocational Nurse license, First Aid Certification and a CPR Certification before start of employment. Valid California Driver's License.

PHYSICAL STANDARDS AND WORKING CONDITIONS:

The physical and mental demands and work environment described here are representative of those that must be met by employees to successfully perform the essential functions of this class. Reasonable accommodations may be made to enable individuals with disabilities to perform the essential functions. These physical demands are generic in nature and tasks may vary dependent on specific trade and or specialized work assignment.

Physical Demands:

Ability to lift up to 50 pounds without assistance, and be physically able to assist students who may have physical disabilities. Dexterity of hands and fingers to work with students. Standing or sitting for an extended period of time. Reaching overhead, above the shoulders and horizontally to work with and assist students. Some walking and standing on various surfaces as well as bending and reaching at the waist, below and above shoulder level, kneeling, and crouching. Repetitive use of fingers and hands to operate a keyboard and other office equipment is necessary; hearing and speaking ability sufficient to provide information via phone, radio, intercom and personal contact is also needed. Specific vision abilities including close vision, depth perception and the ability to focus are required in order to read materials and assist students.

Work Environment:

While performing the duties of this job the employee works in several environments including a school office, classroom, indoor and outdoor environments and on or near student playground equipment as needed. Employees in this position may have a higher level of exposure to infection and physical injury from students. This position may also involve the following: frequent interruption and direct contact with staff and the public; a high volume of responsibilities that may require working without direct and/or constant supervision; and working in a school office environment where the noise level is usually moderate.

The information contained in the physical standards description is for compliance with ADA and is not an exhaustive list of duties performed. Individuals who hold this position may perform additional duties and additional duties may be assigned.

WORK PERIOD: 10 months per year, 5 days per week, 8.0 hours per day

Nurse's Assistant

GREAT FUTURES START HERE.



BOYS & GIRLS CLUBS
OF LA HABRA

Serving the community since 1955

MEMBER OF BOYS & GIRLS CLUBS OF AMERICA
MEMBER OF LA HABRA COMMUNITY COLLABORATIVE
MEMBER OF BOYS & GIRLS CLUBS OF ORANGE COUNTY PROFESSIONAL ASSN.
MEMBER OF BOYS & GIRLS CLUBS OF ORANGE COUNTY AREA COUNCIL

**CORPORATE
BOARD OF DIRECTORS**

CINDY SINGER
President

*DAWN F. STILLE
Treasurer

BELINDA L. KAHN
Secretary

JACK BROWN

JOAN S. CAVANAGH

RANDY CLAYTON

MICHAEL DOWNING

HENRY ESPARZA

KATHY FELIX

RAY FERNANDEZ

*RICHARD HERMANN

JONATHAN HUGHES

*JASON JAMISON

*RICHARD JONES

*CHRISTINE KENNEDY

*WARREN KRAFT

*DAVID LITTLE

TOM MAUK

*DAVE McCAULEY

*DAREN NIGSARIAN

*KENT ROBERTS

*STEVE SIMONIAN

JANE WILLIAMS

HONORARY
BOARD MEMBERS

CARLENE COOK

CARLOS ROMO

MARK A. CHAVEZ
CPO/Executive Director

*Denotes Past Presidents

MEMORANDUM OF UNDERSTANDING

BGC La Habra

After-School Campus Sites – Lowell Joint USD – K -6 Schools ..

The memorandum of Understanding is made and entered into by the Boys & Girls Clubs of La Habra and Lowell Joint School District, specifically "After-school programming in K-6 Schools in La Habra, California." This collaboration and partnership's purpose is that of recreation, enrichment, safety, educational activities. This project is consistent with the mission of the Boys & Girls Clubs of La Habra of assisting young people to positively contribute to their community. The Boys & Girls Clubs of La Habra has been involved in several collaborations and active in the community of over 67 years. This is a fee based program.

The Boys & Girls Clubs of La Habra agree to provide after school programming and educational services which include, but are not limited to:

- On-campus afterschool services from 1:30-6:00 Monday - Friday
- Community mobilization
- Snacks provided daily
- Tutoring/Homework help
- Safety & Supervision
- Enrichment
- Start August 17, 2022 – June 4, 2023

The Lowell Join School District agrees to allow Boys & Girls Clubs of La Habra personnel, director, to visit and provide services. We will work closely with the schools' teachers and keep all lines of communications open with each principal.



UNITS

ARBOLITA EL CERRITO EL PORTAL IMPERIAL LADERA PALMA LA HABRA
LAS LOMAS LAS POSITAS SIERRA VISTA WALNUT WASHINGTON

This Memorandum of Understanding is effective upon Lowell Joint School District approval.

Signed: Mark A. Chavez Date: 7/25/22
Mark A. Chavez
Executive Director
Boys & Girls Clubs of La Habra

Signed: Jim Coombs Date: 7/25/22
Jim Coombs
Superintendent of Schools
Lowell Joint School District

7/28/22

Addendum

Boys & Girls Clubs of La Habra addendum to the Memorandum of Understanding with the Lowell Joint Unified School District signed by Jim Coombs, Superintendent on July 25, 2022.

Starting and ending dates are August 17, 2022 – June 2, 2023

7/28/22

Addendum no. 2

Boys & Girls Clubs of La Habra addendum to the Memorandum of Understanding with the Lowell Joint Unified School District, signed by Jim Coombs, Superintendent on July 25, 2022.

Time of service for all 5 Lowell Elementary schools for 22/23 school year. Mondays, TK/Kinder are out at 1:15; on minimum days/early release TK/k dismiss at 12:40 and everyone else at 1:05